

Festoon Systems for Square Rails

Program 0270 | 0280



Contents

System Arrangement	5
Square Rails for Curved Track	5
Cable Trolley System for Flat Cables	5
Cable Trolley System for Round Cables	5
Square Rails and Accessories for Curved Track Program 0270	6
Square Rails 30 x 30	6
90° Curves	6
Track Couplers	6
Support Brackets	7
End Stops	7
Drilling Fixture	7
End Caps	7
Cable Trolleys for Flat Cable Program 0270	8
Plastic Cable Trolley and Cable Support	8
Steel Cable Trolley and Cable Support	8
Cable Trolleys for Round Cable and Hose Program 0270	10
Plastic Cable Trolleys with Ball Joints	10
Plastic Cable Trolleys with Brackets	11
Ideal Control Unit Trolley Program 0270	12
Ideal Control Unit Trolley with Plug and Socket Connection	12
Ideal Control Unit Trolley with Plastic Terminal Box	12
Square Rails and Accessories for Curved Track Program 0280	13
Square Rails 40 x 40	13
90° Curves	13
Track Couplers	13
Support Brackets	13
End Stops	14
Drilling Fixture	14
End Caps	14
Cable Trolleys for Flat Cable/Round Cable Program 0280	15
Steel Cable Trolleys for Flat Cables	15
Steel Cable Trolleys for Round Cables	15
Accessories for Cable Trolley Program 0270/0280	16
Support Arms	16
Towing Arms	18
Tow Ropes	18
Girder Clips	18
Example of Use	19
Project Planning	20
Determining the Support Distance	20
Load Diagram	20
Technical Data	22
Calculating the number of Cable Loops, required Cable Length and Loop Length	22



System Arrangement

Square Rails for Curved Track

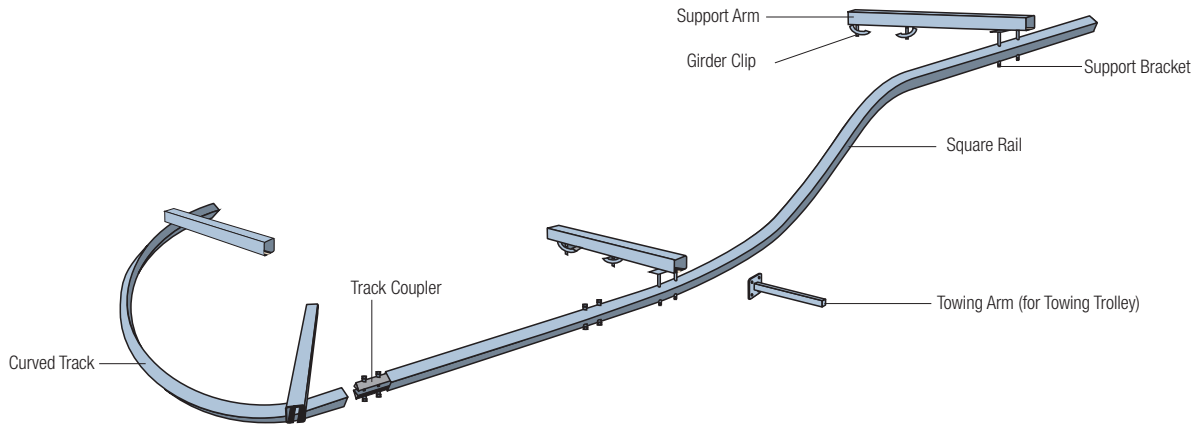

Cable Trolley System for Flat Cables

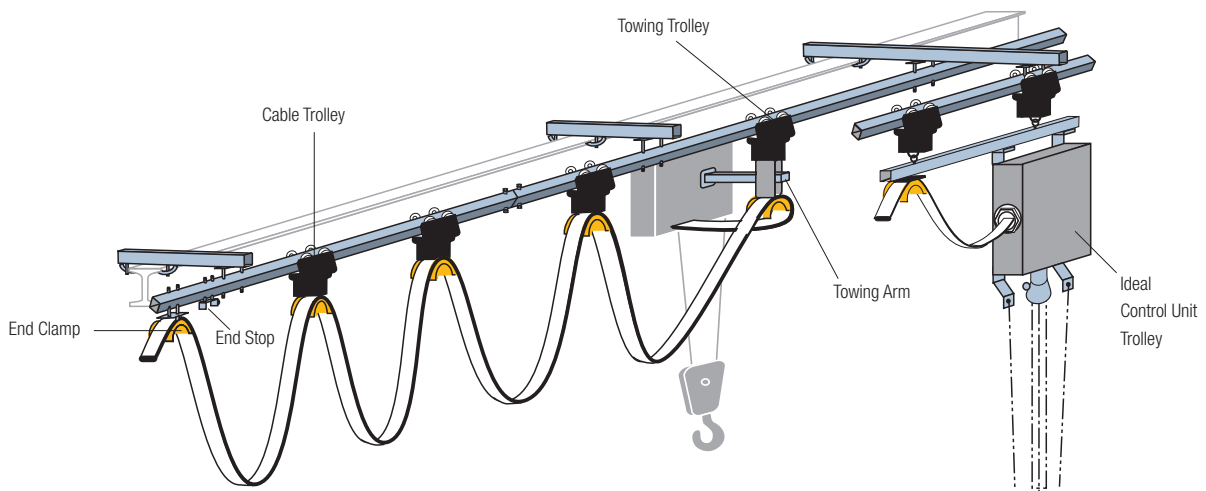

Cable Trolley System for Round Cables

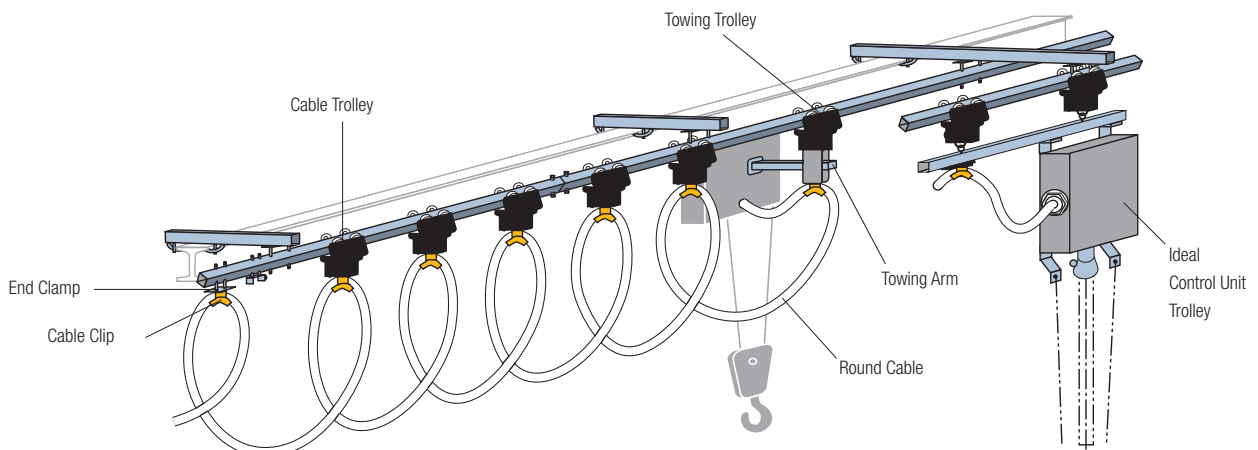

Square Rails and Accessories for Curved Tracks Program 0270

Square Rails 30 x 30

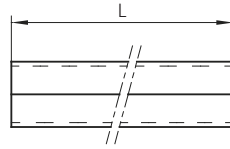
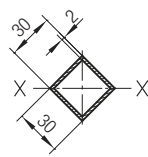
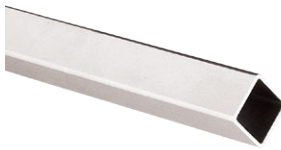

Part No.	Material	L [mm]	Static Values	Weight [kg/m]
027200-6	Galvanized Steel	6000	$I_x = 2.95 \text{ cm}^4$ $W_x = 1.39 \text{ cm}^3$	1.77
027200-4*	Steel	4000		
027400-6	Stainless Steel	6000		
027400-4	Steel (V4A)	4000		

* Standard range

90° Curves

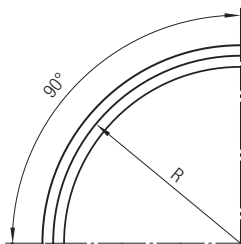

Part No.	Material	R [mm]	Stretched Length [mm]	Cable Loop max. 0.7 x R	Weight [kg]
027203-00400*	Galvanized Steel	400	630	280	1.10
027203-00600*		600	945	420	1.70
027203-00800*		800	1260	560	2.25
027203-01000*		1000	1570	700	2.80
027203-01200*		1200	1885	840	3.35
027203-01400*		1400	2200	980	3.90
027203-01600*		1600	2510	1120	4.45
027203-01800*		1800	2890	1260	5.00
027203-02000*		2000	3140	1400	5.55
027403-01000	Stainless Steel (V4A)	1000	1570	700	2.80
027403-01200		1200	1885	840	3.35
027403-01400		1400	2200	980	3.90
027403-01600		1600	2510	1120	4.45
027403-01800		1800	2890	1260	5.00
027403-02000		2000	3140	1400	5.55

* Standard range

Track Couplers

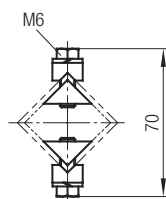
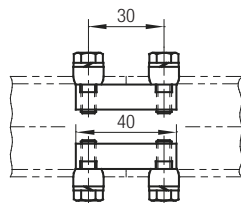

Part No.	Material	Weight [kg]
027210*	Galvanized Steel	0.10
027410	Stainless Steel (V4A)	0.10

* Standard range

Square Rails and Accessories for Curved Tracks Program 0270

Track Support Brackets

For ceiling mounting

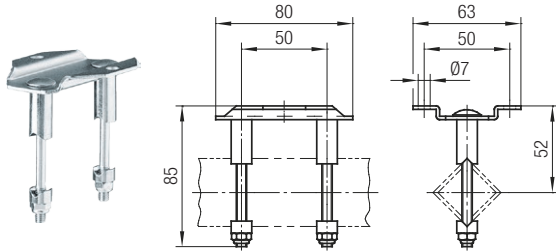

Part No.	Material	Max. Load [kg]	Weight [kg]
027220*	Galv. Steel	125	0.14
027420	SST (V4A)	125	0.14

* Standard range

For mounting on Support Arms 30 x 32 x 2 and 40 x 40 x 2.5 mm

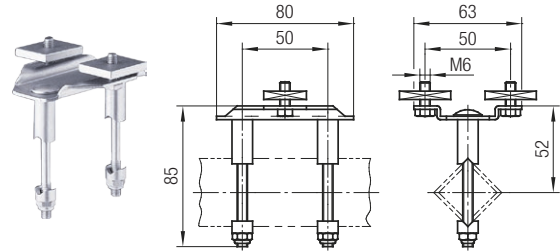

Part No.	Material	Max. Load [kg]	Weight [kg]
027222*	Galv. Steel	125	0.14
027422	SST (V4A)	125	0.14

* Standard range

End Stops for Plastic Cable Trolleys

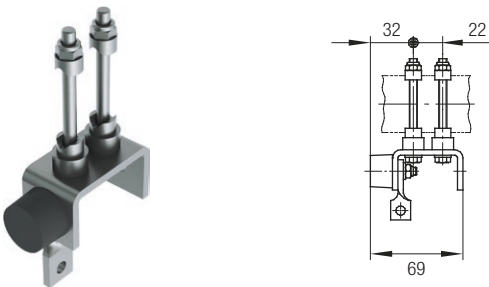

Part No.	Material	Weight [kg]
027112*	Galvanized Steel; Rubber Buffer	0.21
027408	Stainless Steel (V4A); Rubber Buffer	0.21

* Standard range

End Stop for Steel Cable Trolleys

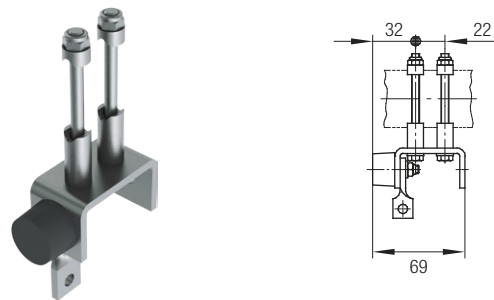

Part No.	Material	Weight [kg]
027111*	Galvanized Steel; Rubber Buffer	0.21

* Standard range

Drilling Fixture

For drilling holes into rails and curves

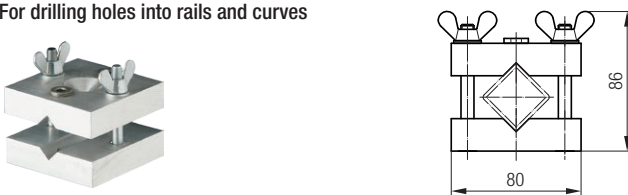

Part No.	Material	Weight [kg]
027211	Body: Aluminum Drill Sleeve: Hardened Steel Fasteners: Galvanized Steel	1.00

End Cap

For closing Rail Ends

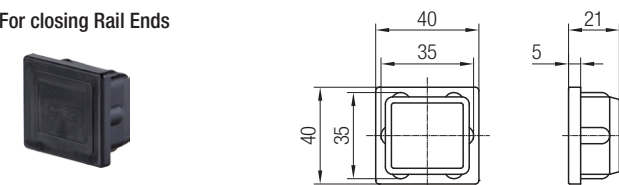

Part No.	Material	Weight [kg]
020662-31*	Plastic	0.004

* Standard range

Cable Trolleys for Flat Cables Program 0270

Plastic Cable Trolley and Cable Support



Rollers:
Ball Bearings, galvanized;
Cover Plate ZZ.
Max. Load Capacity: 16 kg

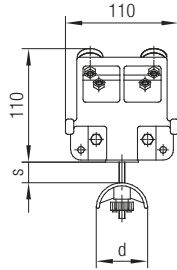

Cable Trolley

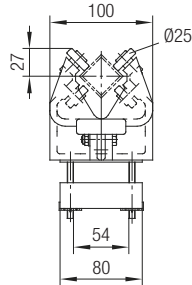

Towing Trolley

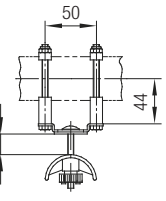
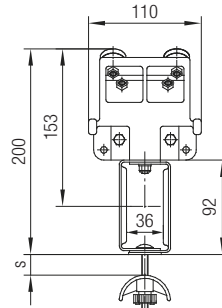

End Clamp

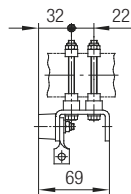

End Stop
Part No. 027112

Cable Trolley Part No.	[kg]	Towing Trolley Part No.	[kg]	End Clamp Part No.	[kg]	d [mm]	s [mm]
027261*	0.60	027267*	1.01	027268*	0.21	50	25
027271*	0.62	027277*	1.03	027278*	0.23	80	15
027461 ¹⁾	0.60	027467 ¹⁾	1.01	027468 ¹⁾	0.21	50	25
027471 ¹⁾	0.62	027477 ¹⁾	1.03	027478 ¹⁾	0.23	80	15

* Standard range

¹⁾ Stainless Steel (V4A) / Acid-resistant plastic

Galvanized Steel Cable Trolley and Cable Support; Light Series



Cable Trolley Part No.	[kg]	Towing Trolley Part No.	[kg]	End Clamp Part No.	[kg]	d [mm]	s [mm]
027339-125x100*	2.10	027349-125x100*	2.63	027329-100x042*	0.54	50	30
027340-125x100*	2.15	027350-125x100*	2.68	027330-100x068*	0.61	80	15

* Standard range

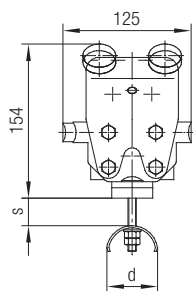

Cable Trolley

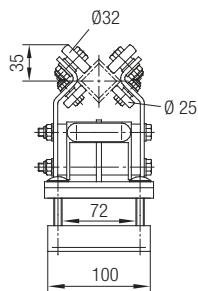

Towing Trolley

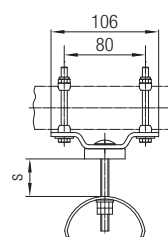
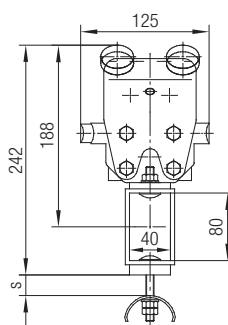

End Clamp

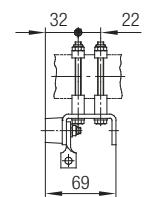

End Stop
Part No. 027111

Cable Trolleys for Flat Cables Program 0270

Galvanized Steel Cable Trolley and Cable Support; Heavy Duty Series

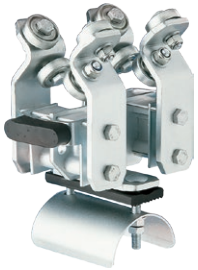

Rollers:
Ball Bearings, galvanized;
Cover Plate ZZ.
Max. Load Capacity: 25 kg

Cable Trolley Part No.	[kg]	Towing Trolley Part No.	[kg]	End Clamp Part No.	[kg]	d_a [mm]	l_w [mm]	b_1 [mm]	b_2 [mm]	s [mm]	k [mm]	
027310-160x100*	2.87	027320-200x100*	3.52	027330-100x068*	0.68	80	160	100	72	38	101	
027310-160x160*	3.11	027320-200x160*	4.03	027330-160x068*	0.92			160	132			
027310-200x100	2.99	027320-200x100*	3.52	027330-100x068*	0.68		200	100	72	58		
027310-200x160	3.23	027320-200x160*	4.03	027330-160x068*	0.92			160	132			
027312-200x100*	3.09	027322-200x100*	3.69	027332-100x048*	0.78	125	200	100	72	35	141	
027312-200x160*	3.42	027322-200x160*	4.22	027332-160x048*	1.11			160	132			
027313-250x100*	3.34	027323-250x100*	3.94	027333-100x048*	0.98	160	250	115	72	42		181
027313-250x160*	3.76	027323-250x160*	4.56	027333-160x048*	1.38			175	132			

* Standard range

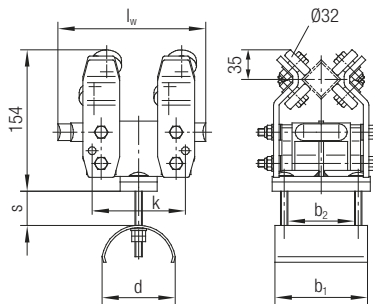

Cable Trolley

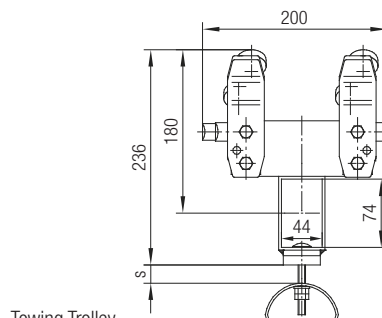

Towing Trolley
 $l_w \leq 200$

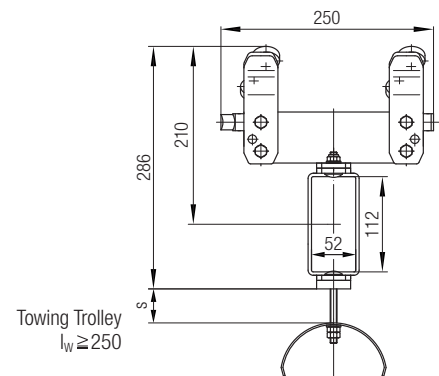

Towing Trolley
 $l_w \geq 250$

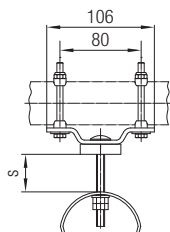

End Clamp

Cable Trolleys for Round Cable and Hose Program 0270

Plastic Cable Trolleys with Ball Joints for Cable Clips (Part No. 020131 below)

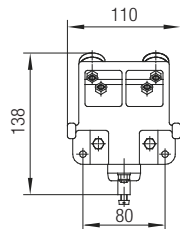

Cable Trolley
Part No. 027291

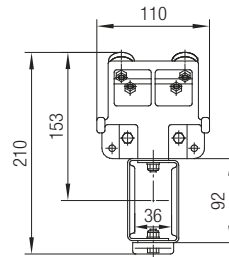
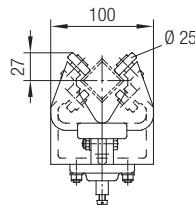

Towing Trolley
Part No. 027297

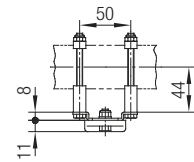

End Clamp
Part No. 027298

Rollers:
Ball Bearings, galvanized;
Cover Plate ZZ.
Max. Load Capacity: 16 kg

Several Cable Clips
can be combined

End Stop
Part No. 027112

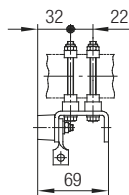

Cable Trolley Part No.	[kg]	Towing Trolley Part No.	[kg]	End Clamp Part No.	[kg]
027291*	0.59	027297*	0.97	027298*	0.18
027491 ¹⁾	0.59	027497 ¹⁾	0.97	027498 ¹⁾	0.18

* Standard range

¹⁾ Stainless Steel (V4A) / Acid-resistant plastic

Cable Clips - to be connected to the Trolley Ball Joint

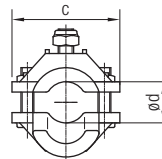
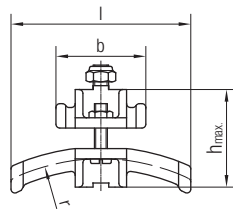

Part No.	for Cables ø d [mm]	r [mm]	l [mm]	h [mm]	b [mm]	c [mm]	Body Material	Hardware Finish	Weight [kg]
020131-16*	10...16	80	70	38	35	42	Plastic	Galvanized Steel	0.04
020131-25*	17...25	125	100	47	50	50			0.06
020131-36*	26...36	180	140	58	70	64			0.12
020431-16	10...16	80	70	38	35	42	Acid-resistant Plastic	Stainless Steel V4A	0.04
020431-25	17...25	125	100	47	50	50			0.06
020431-36	26...36	180	140	58	70	64			0.12

* Standard range

Cable Trolleys for Round Cable and Hose Program 0270

Plastic Cable Trolleys with Brackets for Cable Clips (Part No. 020133 below)

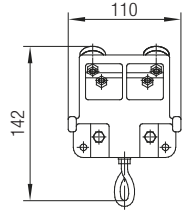

Cable Trolley
Part No. 027281

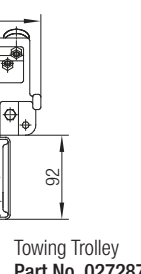
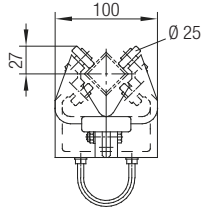

Towing Trolley
Part No. 027287

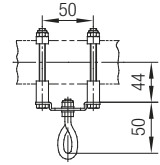

End Clamp
Part No. 027288

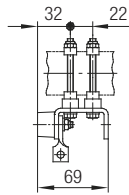

End Stop
Part No. 027112

Rollers:
Ball Bearings, galvanized;
Cover Plate ZZ.
Max. Load Capacity: 16 kg

Cable Trolley Part No.	[kg]	Towing Trolley Part No.	[kg]	End Clamp Part No.	[kg]
027281*	0.57	027287*	0.99	027288*	0.21

* Standard range

Cable Clips - to be connected to the Trolley Bracket

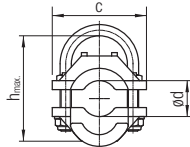
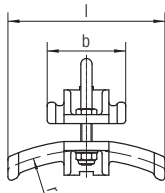

Part No.	for Cables $\varnothing d$ [mm]	r [mm]	l [mm]	h [mm]	b [mm]	c [mm]	Weight [kg]
020133-16*	10...16	80	70	48	35	42	0.05
020133-25*	17...25	125	100	60	50	50	0.07
020133-36*	26...36	180	140	78	70	64	0.14

* Standard range

Material: Plastic;
Fasteners:
Galvanized Steel

Cable Clips 020131 can be mounted underneath Cable Clips with Brackets 020133

Galvanized Steel Cable Trolleys; Heavy Duty Series



Cable Trolley Part No.	[kg]	Towing Trolley Part No.	[kg]	End Clamp Part No.	[kg]	d_a [mm]	l_w [mm]	b_1 [mm]	b_2 [mm]	s [mm]	k [mm]
027873-200x100	3.44	027883-200x100	4.21	027893-100	1.06	160	200	115	65	16	141
027873-200x160	3.86	027883-200x160	4.75	027893-160	1.18			175	125		
027874-250x160	4.21	027884-250x160	5.10	027894-160	1.83	200	250	175	125	20	181
027874-250x200	4.61	027884-250x200	5.38	027894-200	2.23			215	165		
027875-320x160	4.66	027885-320x160	5.55	027895-160	2.08	250	320	175	125	25	251
027875-320x200	5.06	027885-320x200	5.83	027895-200	2.48			215	165		

Rollers:
Ball Bearings, galvanized;
Cover Plate ZZ.
Max. Load Capacity: 25 kg

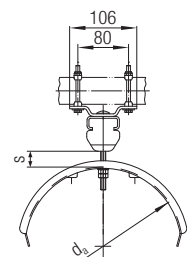
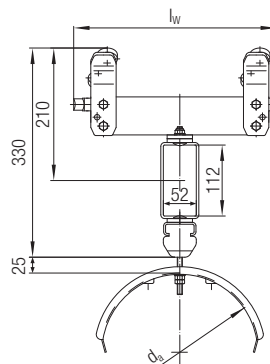
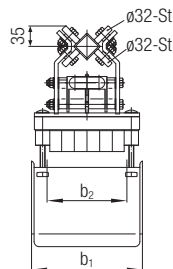
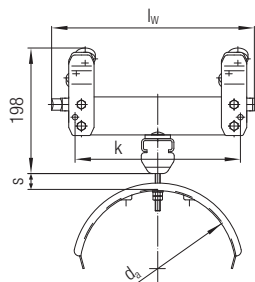

Ideal Control Unit Trolley Program 0270

Ideal Control Unit Trolley with Plug and Socket Connection

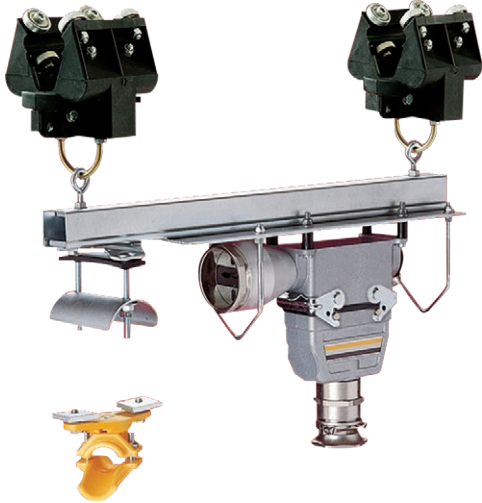

Rated Voltage 400 V; Rated Current 16 A;
Protection Type IP55 as defined by DIN 40050;
Screw Connection 2.5 mm²

Part No.	Number of poles	Fittings		Weight [kg]
		①	②	
027178-16*	16 + PE	25x42	25x21	3.72
027178-24*	24 + PE	25x42	32x29	4.10

* Standard range

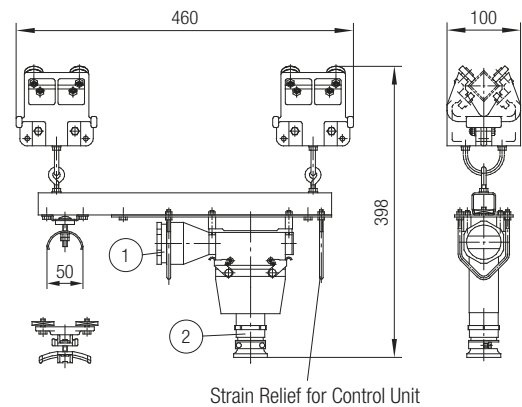

Ideal Control Unit Trolley with Plastic Terminal Box



Rated Voltage 400 V; Rated Current 16 A;
Protection Type IP55 as defined by DIN 40050;
Terminal Block 4 mm²

Part No.	Number of poles	Fittings		Weight [kg]
		①	②	
027174-16*	16 + PE	50x42	25x21	5.46
027174-24	24 + PE	50x42	32x29	5.86

* Standard range

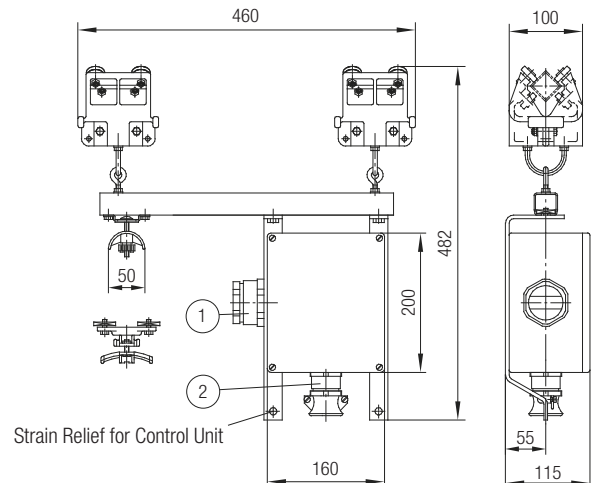

Square Rails and Accessories for Curved Tracks Program 0280

Square Rail 40 x 40

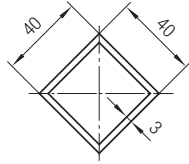
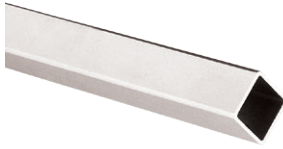

Part No.	Material	L [mm]	Static Values	Weight [kg/m]
028100-6*	Galvanized Steel	6000	$I_x = 9.91 \text{ cm}^4$ $W_x = 3.66 \text{ cm}^3$	3.32

* Standard range

90° Curves

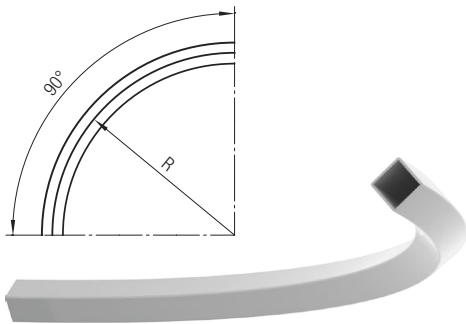

Part No.	Material	R [mm]	Stretched Length [mm]	Cable Loop max. 0.7 x R	Weight [kg]
028102-01000*	Galvanized Steel	1000	1570	700	5.20
028102-01200*		1200	1885	840	6.25
028102-01400*		1400	2200	980	7.30
028102-01600*		1600	2510	1120	8.30
028102-01800*		1800	2890	1260	9.60
028102-02000*		2000	3140	1400	10.40

* Standard range

Track Coupler

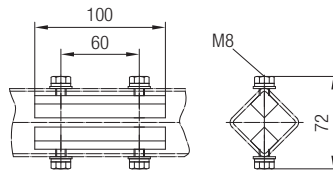

Part No.	Material	Weight [kg]
028105*	Galvanized Steel	0.33

* Standard range

Track Support Bracket for Ceiling Mounting

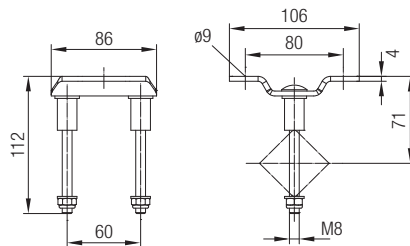

Part No.	Material	Max. Load [kg]	Weight [kg]
028120*	Galvanized Steel	250	0.33

* Standard range

Track Support Bracket for mounting on Support Arm 40 x 40 x 2.5 mm

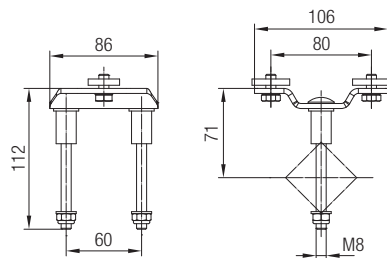

Part No.	Material	Max. Load [kg]	Weight [kg]
028121*	Galvanized Steel	250	0.39

* Standard range

Accessories for Program 0280

End Stop

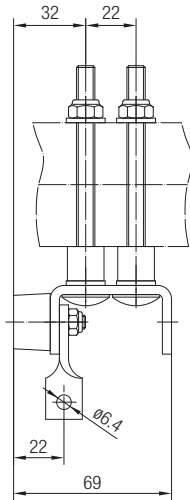

Part No.	Material	Weight [kg]
028111*	Galvanized Steel; Rubber Buffer	0.22

* Standard range

Drilling Fixture

For drilling holes into rails and curves

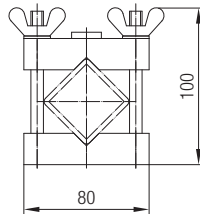

Part No.	Materials	Weight [kg]
028107	Body: Aluminum Drill Sleeve: Hardened Steel Fasteners: Galvanized Steel	1.09

End Cap

For closing Rail Ends

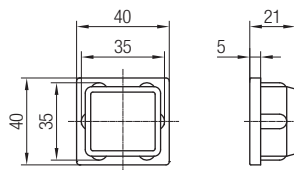

Part No.	Material	Weight [kg]
020662-40*	Plastic	0.004

* Standard range

Cable Trolleys for Flat Cable/Round Cable Program 0280

Galvanized Steel Cable Trolleys; for Flat Cables



Cable Trolley Part No.	[kg]	Towing Trolley Part No.	[kg]	End Clamp Part No.	[kg]	d_a [mm]	l_w [mm]	b_1 [mm]	b_2 [mm]	s [mm]	k [mm]	l_m [mm]
028250-200x100*	4.62	028260-200x100*	5.26	028230-100x068*	0.57	80	200	100	72	45	130	100
028250-200x160*	4.86	028260-200x160*	5.62	028230-160x068*	0.86			160	132			
028252-250x100*	4.91	028262-250x100*	5.55	028232-100x068*	0.68	125	250	100	72	50	180	125
028252-250x160*	5.24	028262-250x160*	6.00	028232-160x068*	1.34			160	132			
028253-250x160*	5.34	028263-250x160*	6.10	028233-160x068*	1.50	160	250	175	132	35	180	125
028253-250x200*	5.73	028263-250x200*	6.37	028233-200x068*	1.95			215	172			
028253-290x160	5.44	028263-320x160	6.20	028233-160x068*	1.50		288 ¹⁾	175	132	50	250	160
028253-290x200	5.83	028263-320x200	6.47	028233-200x068*	1.95			215	172			

* Standard range

¹⁾ Cable Trolley with Rubber Buffer on one side

Rollers:
Ball Bearings, galvanized;
Sealing Disk RS.
Max. Load Capacity: 36 kg

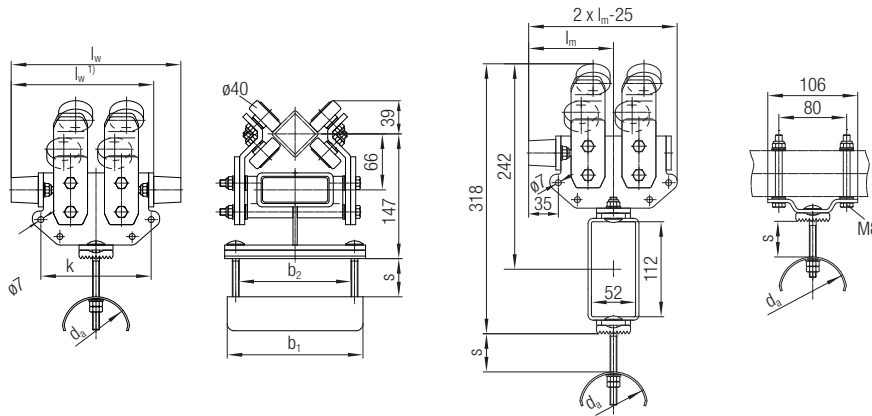

Galvanized Steel Cable Trolleys; for Round Cables



Cable Trolley Part No.	[kg]	Towing Trolley Part No.	[kg]	End Clamp Part No.	[kg]	d_a [mm]	l_w [mm]	b_1 [mm]	b_2 [mm]	s [mm]	k [mm]	l_m [mm]
028464-250x100	5.15	028474-250x100*	5.92	028394-100*	1.38	200	250	115	65	20	180	125
028464-250x160*	5.72	028474-250x160*	6.61	028394-160*	1.93			175	125			
028465-320x160*	6.17	028475-320x160*	7.10	028395-160*	2.18	250	320	175	125	25	250	160
028465-320x250	6.87	028475-320x250*	7.76	028395-250*	2.88			265	215			
028467-400x160*	7.03	028477-400x160*	7.92	028397-160*	2.78	320	400	175	132	32	330	200
028467-400x250	7.83	028477-400x250	8.72	028397-250	3.58			265	215			

* Standard range

Rollers:
Ball Bearings, galvanized;
Sealing Disk RS.
Max. Load Capacity: 36 kg

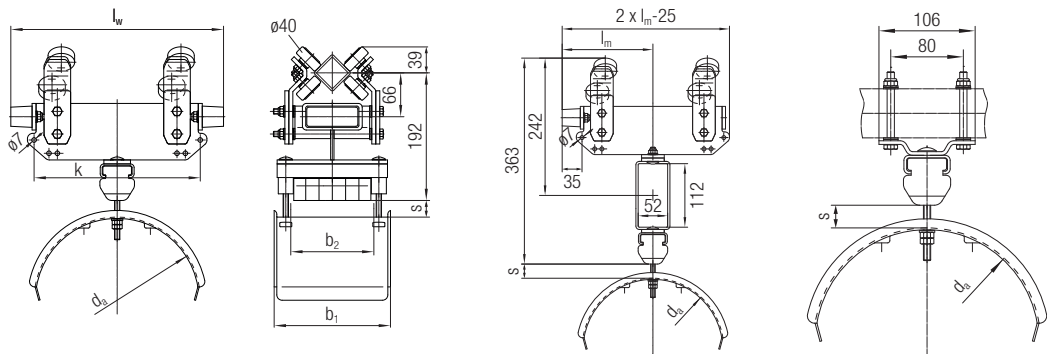

Accessories for Cable Trolleys Program 0270/0280

Punched Support Arms 30 x 32 x 2 mm for Program 0270

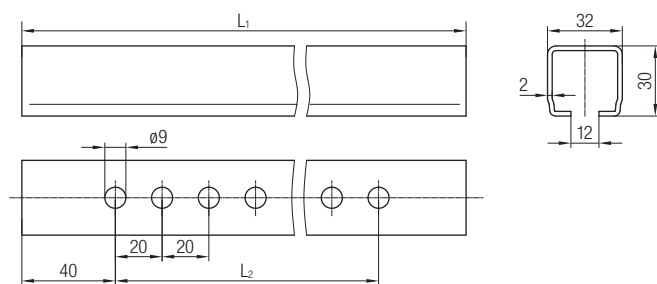
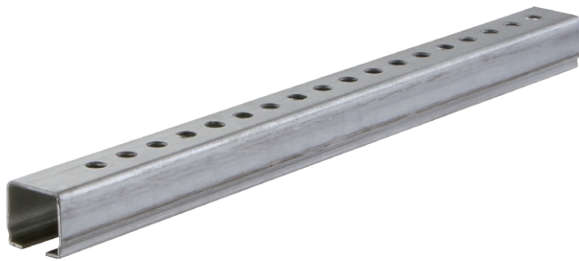

Part No.	L ₁ [mm]	L ₂ [mm]	Material	Weight [kg]
020185-0250	250	200	Galvanized Steel	0.39
020185-0315	315	260		0.50
020185-0400	400	340		0.63
020185-0500*	500	340		0.78
020185-0630	630	340		0.98
020185-0800	800	340		1.25
020185-1000*	1000	340		1.55
020185-1250	1250	340		1.95

* Standard range

Punched Support Arms 40 x 40 x 2.5 mm for Program 0270/0280

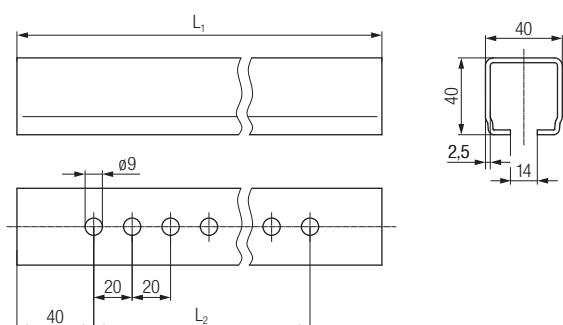
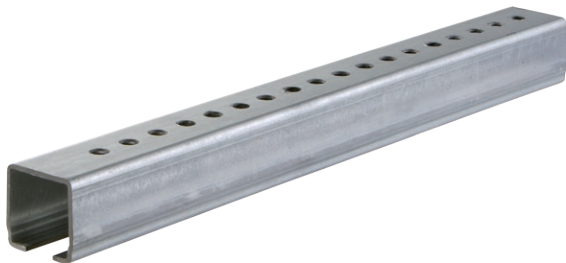

Part No.	L ₁ [mm]	L ₂ [mm]	Material	Weight [kg]
020186-0250	250	200	Galvanized Steel	0.63
020186-0315	315	260		0.79
020186-0400	400	340		1.00
020186-0500*	500	340		1.25
020186-0630	630	340		1.58
020186-0800	800	340		2.00
020186-1000*	1000	340		2.50
020186-1250	1250	340		3.13

* Standard range

Accessories for Cable Trolleys Program 0270/0280

Unpunched Support Arms 30 x 32 x 2 mm for Program 0270

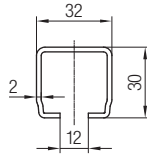
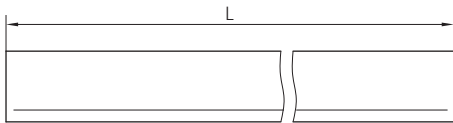

Part No.	L [mm]	Material	Weight [kg]
020275-0250	250	Galvanized Steel	0.39
020275-0400	400		0.63
020275-0500*	500		0.78
020275-0630	630		0.98
020275-0800	800		1.25
020275-1000*	1000		1.55
020275-1250	1250		1.95

* Standard range

Unpunched Support Arms 40 x 40 x 2.5 mm for Program 0270/0280

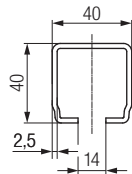
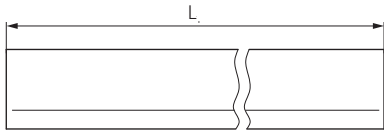

Part No.	L [mm]	Material	Weight [kg]
020276-0450	450	Galvanized Steel	1.13
020276-0550	550		1.38
020276-0650*	650		1.63
020276-0840	840		2.10
020276-0950	950		2.38
020276-1000	1000		2.50
020276-1150*	1150		2.88

* Standard range

Permissible Load for Support Arms

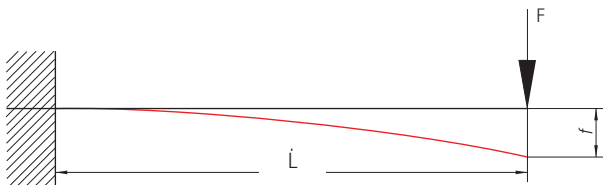

Note:

- Calculated with $\sigma = 140 \text{ N/mm}^2$ tension
- f = associated max. deflection

		L [mm]								
		0.25	0.40	0.50	0.65	0.80	1.00	1.25	1.52	2.00
Support Arm 30 x 32 x 2 mm	F [kg]	76.0	47.5	38.0	29.0	24.0	19.0	15.0	12.5	9.50
	f [cm]	0.08	0.20	0.32	0.60	0.90	1.40	2.20	3.30	5.70
Support Arm 40 x 40 x 2.5 mm	F [kg]	164.5	103.0	82.0	63.0	51.5	41.0	33.0	27.0	20.5
	f [cm]	0.07	0.20	0.30	0.45	0.70	1.10	1.70	2.50	4.30

Accessories for Cable Trolleys Program 0270/0280

Towing Arms

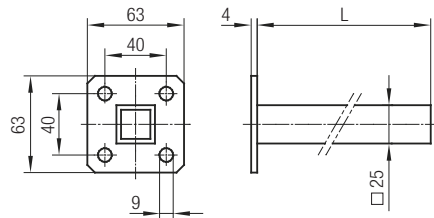

Part No.	L [mm]	Material	Weight [kg]
020195-400	400	Galvanized Steel	0.60
020195-630*	630	Steel	1.00

* Standard range

Tow Ropes



Type A

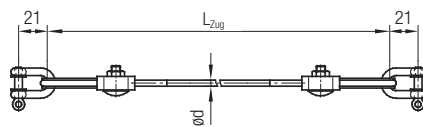

Type B

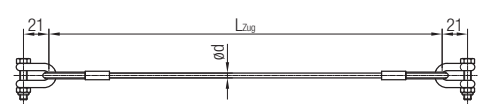

Part No.	ød [mm]	Type	Material	Weight [kg]	for Program
020316-04*	4	A	Plastic	0.12	0270 Plastic Cable Trolleys
020329-04*	4	B	Galv. Steel; PVC jacket	0.16	0270 Steel Cable Trolleys; 0280
020328-04*	4	B	Galvanized Steel	0.20	0270 Steel Cable Trolleys; 0280

* Standard range

Girder Clips, clamping thickness range 4 - 20 mm

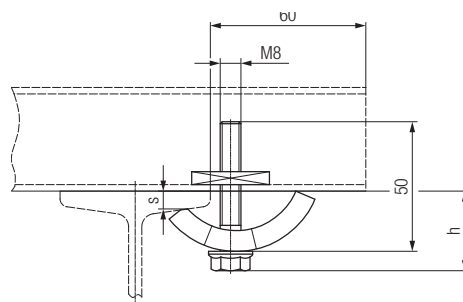

Part No.	Material	Weight [kg]
020180-08*	Galvanized Steel	0.15
020480-08	Stainless Steel V4A	0.15

* Standard range

Clamping thickness	s	4	6	8	10	12	16	20
Installation height	h	31	32	33	34	35	37	40

Accessories for Cable Trolleys Program 0270/0280

Application Example

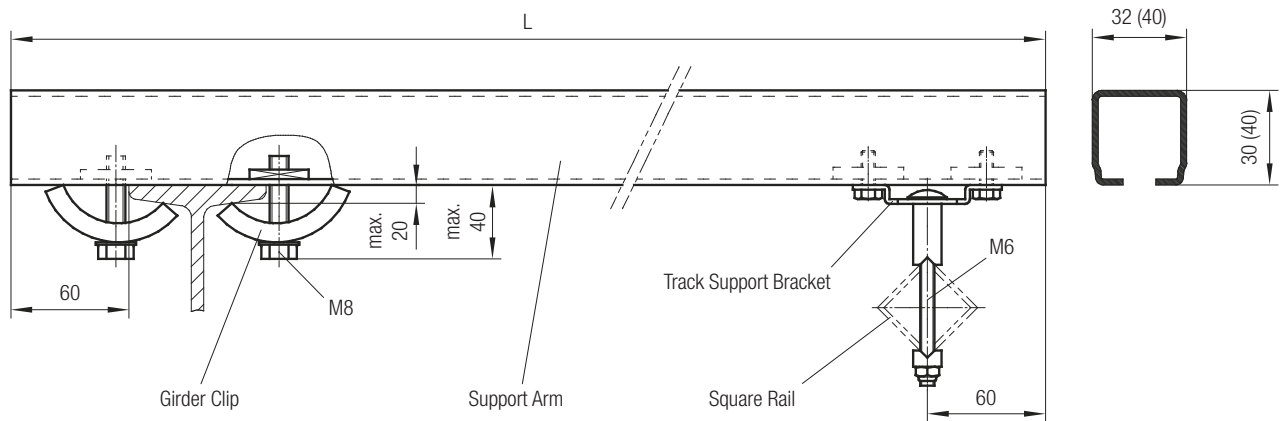

Project Planning

Determining the Support Distance for Square Rail Program 0270

Technical Data / Calculation Assumptions

The required support distance of the square rail can be determined using the diagram below. The following calculation assumptions have been taken into consideration:

1. Simply-supported beam, uniform load symmetrical to middle of the beam
2. The load of one trolley F_{LW} [kg/trolley] is distributed over trolley length l_w as a uniform load p [kg/m]
3. Total length of the uniform load results from the cable trolley storage length l_b [m] of all trolleys side by side
4. $\sigma_{b_{zul}} = 100 \text{ N/mm}^2$
5. $f = l_w/250$ permissible deflection from the load and net weight of the rail
6. As track support bracket load the load of a field symmetrical to the mounting (bracket) is assumed

Example:

Given:

F_{LW} = Cable Trolley Load: 3.6 kg (X axis value on the left-hand graph below)
 l_w = Cable Trolley Length: 110 mm (blue line on the left graph)
 Z = Overall number of Cable Trolleys: 9
 l_b = Cable Trolley Storage Length: 0.99 m (X axis on the right-hand graph below)
 (m) = $Z \times l_w / 1000$

Load Diagram for Square Rail 30 x 30 x 2 (020275)

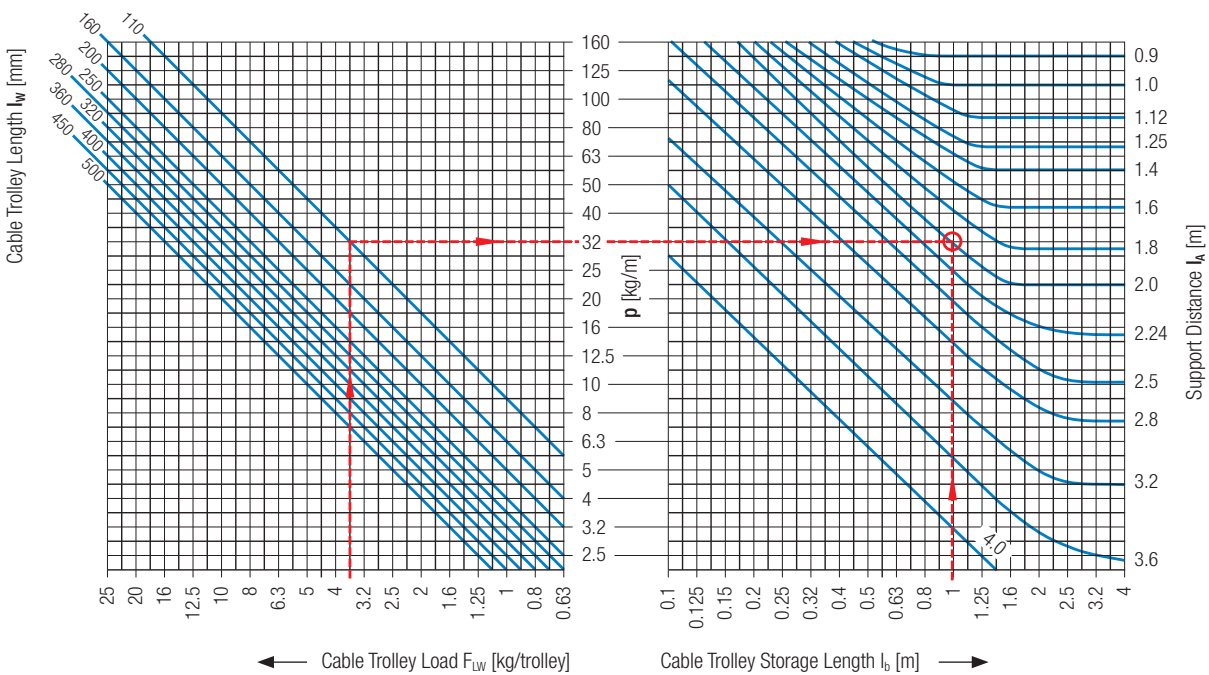

Result for Square Rail 30 x 30 x 2

From Diagram:

Required Support Distance $l_A = 2.0 \text{ m}$

Note: Support distance in curves should not exceed two thirds of the required support distance for a straight track.

Project Planning

Determining the Support Distance for Square Rail Program 0280

Technical Data / Calculation Assumptions

The required support distance of the square rail can be determined using the diagram below. The following calculation assumptions have been taken into consideration:

1. Simply-supported beam, uniform load symmetrical to middle of the beam
2. The load of one trolley F_{LW} [kg/trolley] is distributed over trolley length l_w as a uniform load p [kg/m]
3. Total length of the uniform load results from the cable trolley storage length l_b [m] of all trolleys side by side
4. $\sigma_{b_{zul}} = 100 \text{ N/mm}^2$
5. $f = l_w/250$ permissible deflection from the load and net weight of the rail
6. As track support bracket load the load of a field symmetrical to the mounting (bracket) is assumed

Example:

Given:

- F_{LW} = Cable Trolley Load: 18 kg (X axis value on the left-hand graph below)
 l_w = Cable Trolley Length: 200 mm (blue line on the left graph below)
 Z = Overall number of Cable Trolleys: 6
 l_b = Cable Trolley Storage Length: 1.20 m (X axis value on the right-hand graph below)
 (m) = $Z \times l_w / 1000$

Load Diagram for Square Rail 40 x 40 x 3 (020276)

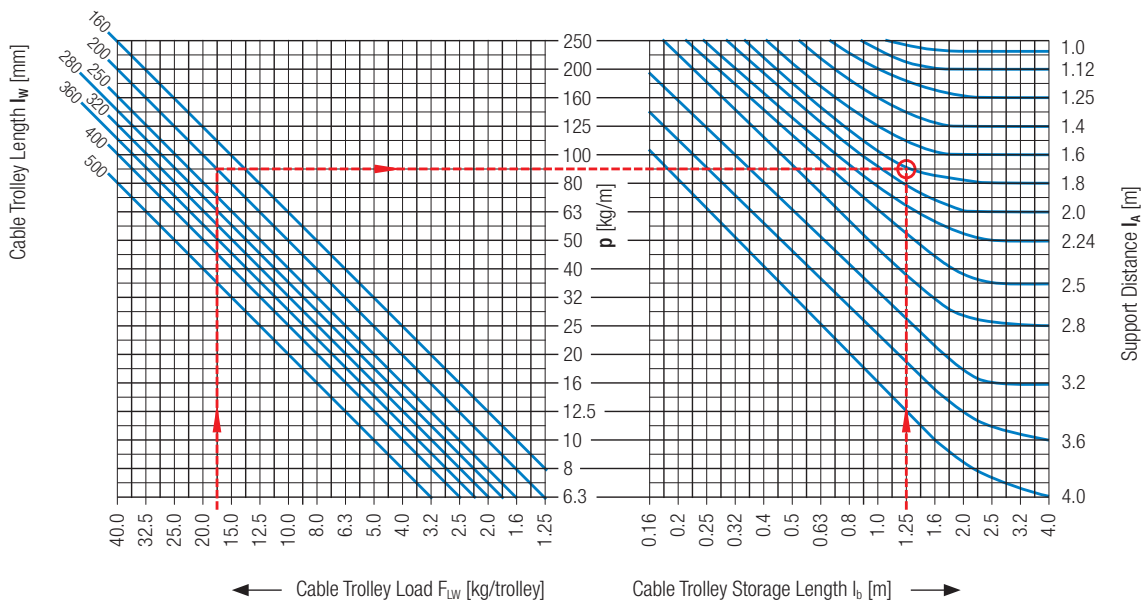

Result for Square Rail 40 x 40 x 3

From Diagram:

Required Support Distance $l_A = 1.8 \text{ m}$

Note: Support distance in curves should not exceed two thirds of the required support distance for a straight track.

Project Planning

Technical Data

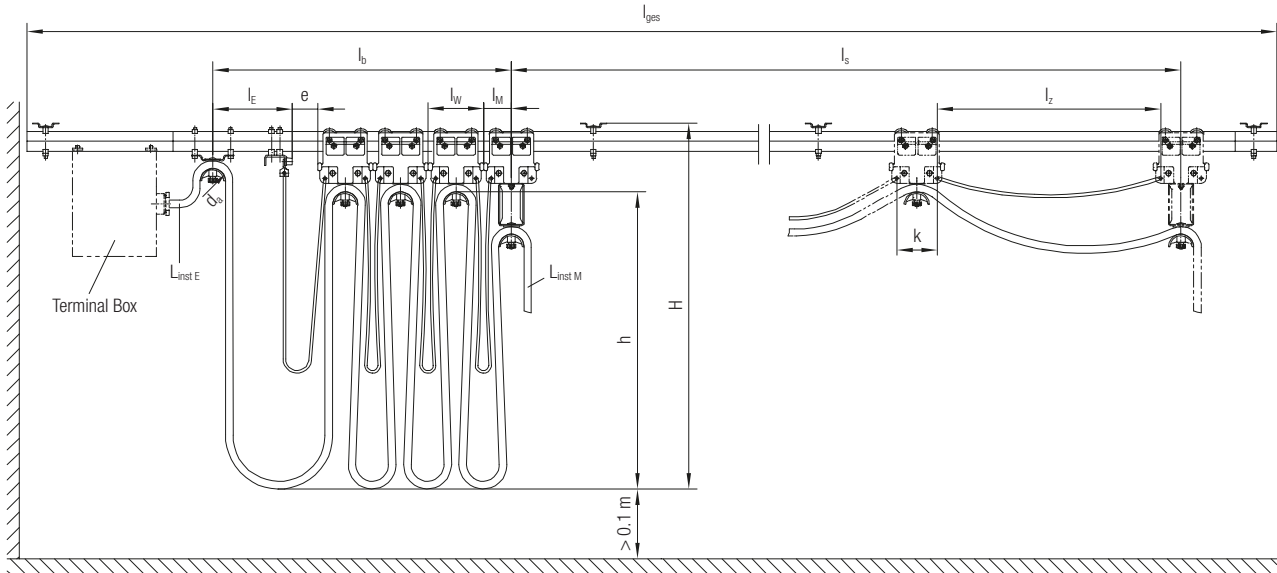

Calculating the number of Cable Loops, required Cable Length, and Loop Length

Number of loops:

$$n = \frac{f(l_s + e)}{2 \cdot h + 1.25 d_a - f \cdot l_w}$$

Cable Trolley storage length:

$$l_b \approx n \cdot l_w + e \quad [m]$$

Cable system length:

$$L_{Syst} = f(l_s + l_b) \quad [m]$$

Total cable length:

$$L_{Best} = L_{Syst} + L_{inst E} + L_{inst M} \quad [m]$$

Required length of tension relief:

$$l_z = \frac{1.05(l_s + l_b)}{n} - k \quad [m]$$

For plastic Cable Trolleys: $k = 0.08 \quad [m]$
 For steel Cable Trolleys: $k = l_w - 0.06 \quad [m]$

Loop length:

$$L_{Schl} = \frac{L_{Syst}}{n} \quad [m]$$

Loop depth:

$$h = \frac{L_{Schl}}{2} - 0.63 \cdot d_a \leq 0.7 \cdot R_{min} \quad [m]$$

- d_a [m] = Cable Support diameter
- e [m] = Tolerance in the Cable Trolley storage length (recommended $\geq 0.1 m$)
- f = Length factor for cables (1.2 for square rails)
- h [m] = Loop depth (measured from top edge of Cable Support)
- H [m] = Overall installation space
- l_b [m] = Cable Trolley storage length incl. tolerance "e"
- l_s [m] = Travel distance
- l_w [m] = Cable Trolley length
- l_z [m] = Length of tension relief
- L_{Best} [m] = Total cable length
- $L_{inst E}$ [m] = Length for fixed installation, End Clamp side
- $L_{inst M}$ [m] = Length for fixed installation, Towing Trolley side
- L_{Schl} [m] = Loop length
- L_{Syst} [m] = Required cable length measured from middle of the End Clamp to middle of the Towing Trolley / Cable Clamp
- n = Number of loops
- R_{min} [m] = Smallest radius for curved track

The maximum permissible cable loop depends on the smallest radius to be passed. Loops which do not pass this radius can be larger accordingly.

Your Applications – our Solutions

Festoon Systems from Conductix-Wampfler represent only one of the many solutions made possible by the broad spectrum of Conductix-Wampfler components for the transport of energy, data and fluid media. The solutions we deliver for your applications are based on your specific requirements. In many cases, a combination of several different Conductix-Wampfler systems can prove advantageous. You can count on all of Conductix-Wampfler's Business Units for hands-on engineering support – coupled with the perfect solution to meet your energy management and control needs.



Festoon systems

It's hard to imagine Conductix-Wampfler cable trolleys not being used in virtually every industrial application. They're reliable and robust and available in an enormous variety of dimensions and designs.

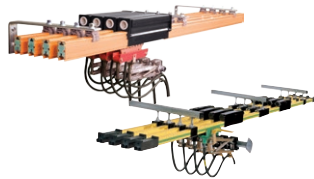

Conductor rails

Whether they're enclosed conductor rails or expandable single-pole systems, the proven conductor rails by Conductix-Wampfler reliably move people and material.

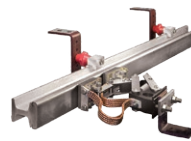

Non-insulated conductor rails

Extremely robust, non-insulated conductor rails with copper heads or stainless steel surfaces provide the ideal basis for rough applications, for example in steel mills or shipyards.



Slip ring assemblies

Whenever things are really "moving in circles", the proven slip ring assemblies by Conductix-Wampfler ensure the flawless transfer of energy and data. Here, everything revolves around flexibility and reliability!



Motorized Cable & Hose Reels

Motorized reels by Conductix-Wampfler hold their own wherever energy, data, media and fluids have to cover the most diverse distances within a short amount of time – in all directions, fast and safe.



Spring Cable & Hose Reels

With their robust and efficient design Spring Cable and Hose Reels from Conductix-Wampfler are unbeatably reliable in supplying energy, signals, data and fluids to a vast range of tools, cranes and vehicles.



Inductive Power Transfer IPT®

The no-contact system for transferring energy and data. For all tasks that depend on high speeds and absolute resistance to wear.



Retractors and Balancers

Our wide range of high reliable retractors and balancers remove the load from your shoulders and allow you to reach top productivity.

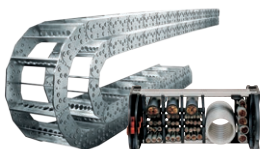

Energy guiding chains

The "Jack of all trades" when it comes to transferring energy, data, air and fluid hoses. With their wide range, these energy guiding chains are the ideal solution for many industrial applications.



Jib booms

Complete with tool transporters, reels, or an entire media supply system – here, safety and flexibility are key to the completion of difficult tasks.

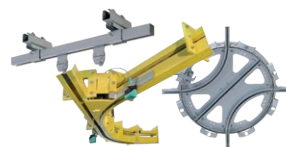

Conveyor systems

Whether manual, semiautomatic or with Power & Free – flexibility is achieved with full customization concerning layout and location.

www.conductix.com

Conductix-Wampfler

has just one critical mission:
To provide you with energy and
data transmission systems that
will keep your operations up
and running 24/7/365.

To contact your nearest
sales office, please refer to:

**[www.conductix.com/
contact-search](http://www.conductix.com/contact-search)**



DELACHAUX GROUP