



PATTON & COOKE CO.

Utility Industry Catalogue



www.pattonandcooke.com



PATTON & COOKE CO.

OUR BEGINNING

Patton & Cooke was established in 1961 in Vancouver, BC Canada by an electrical engineer and an electrical designer with over 40 years combined experience in the design and manufacture of products for the electric utility industry. Patton & Cooke's focus has remained the same throughout the growth of the company - to develop and manufacture high voltage equipment with a commitment to quality products at competitive prices.

OUR PLANT

Patton & Cooke has a modern 30,000 sq/ft plant in Surrey, a rapidly growing suburb of Vancouver, BC. Our location is ideal - we're situated in the heart of Canada's gateway to the Pacific Rim, and only minutes from the United States border.

Our plant has complete Computer Aided Design (CAD/Solidworks), product testing, fabricating and assembly facilities. Quality assurance is paramount and our plant meets the highest applicable industry standards.

OUR SUPPORT

Patton & Cooke's team of field engineers is continually working with customers to co-develop, customize and improve products. This has resulted in many design improvements and innovations.

We also help our customers install, operate and maintain our products and provide valuable in-field training. Such support is an important part of the world-wide reputation we enjoy for rugged and dependable products, backed by skilled and responsive in-field service.

OUR PROMISE

Patton & Cooke designs and manufactures medium voltage electrical equipment with a commitment to delivering quality products at competitive prices.

We will measure our success by:

- Delivering manufactured products that will meet or exceed the standard of quality expected by our customers.
- Working closely with industry partners to develop new, innovative medium voltage products that address the needs of the industries we serve.
- Seeking and promoting strategic industry alliances to ensure the availability of Patton & Cooke products globally, while maintaining the highest levels of customer service.
- Continuing to set the standard for the timely delivery of medium voltage electrical equipment.

As we look to the future, we envision many new and different products, each designed and manufactured to our customers exacting standards, and all sharing in the Patton & Cooke principle: listen to the customer and provide them with quality products that address their needs.

So, if you have a challenge, an obstacle, or an issue making an electrical connection, let us put our knowledge to work for you.





UTILITY PRODUCTS

PATTON & COOKE ELECTROPLASTICS

All Patton & Cooke electroplastic products offer the following features:

- 15 kV, 25 kV and 35 kV voltage class products available
- Support 200 Amp, 600 Amp and 900 Amp interfaces and combinations
- Cast from Patton & Cooke's Engineered Resin EN-4
- Junction bars are fully shielded, fully submersible and resistant to harsh chemicals
- Designed for use with separable insulated connectors, manufactured to ANSI/IEEE Standard 386
- The 200 Amp units incorporate a universal bushing well design, making it possible to use either a loadbreak or deadbreak bushing insert
- All in-line junctions can be equipped with universal mounting brackets that can provide mounting angles from 0° to 60°, "U" straps or special mounting arrangements required for installation in sectionalizing cubicles
- Patton & Cooke mounting brackets are manufactured of stainless steel or, where applicable, powder coated mild steel.
- Parking stands are exclusively made of stainless steel.

JUNCTIONS/SPLICES

Patton & Cooke junction bars were designed to provide a more robust connection point for separable rubber connectors and eliminate the problem of amalgamation when rubber connectors are mated for extended periods of time. Cast from our Engineered Resin EN-4, Patton & Cooke junction bars are designed for vault or apparatus applications and can be used for looping, tapping and sectionalizing.

Patton & Cooke junction bars are available in the following orientations:

Single Phase In-line: All connection points are aligned on a single axis, available with 4" and 6" centers, may be up to 6 points on 4" centers or 4 points on 6" centers, low profile style also available for use in sectionalizing cabinets or in vaults where space is restricted.

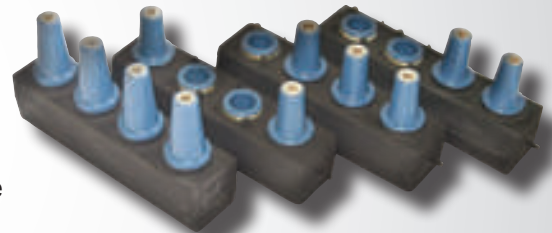

Single Phase Stacked: All connection points are aligned on a two parallel axes, ideal where vault space is limited, may be up to 12 positions on 4" centers or 6 positions on 6.5" centers



Single Phase "L" Configuration: Similar to in-line, but second axis is in perpendicular orientation to the first, ideal where space restrictions limit the ability to bend cable, available with 4" or 6" centers.

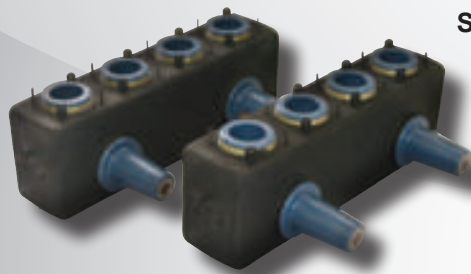

Three Phase "Y" Splice: Similar to "L" splice, but with both second and third axes in perpendicular orientation to the first, available with 4" or 6" centers.





JUNCTION BARS CATALOGUE NUMBERS

200/600/900 Amp

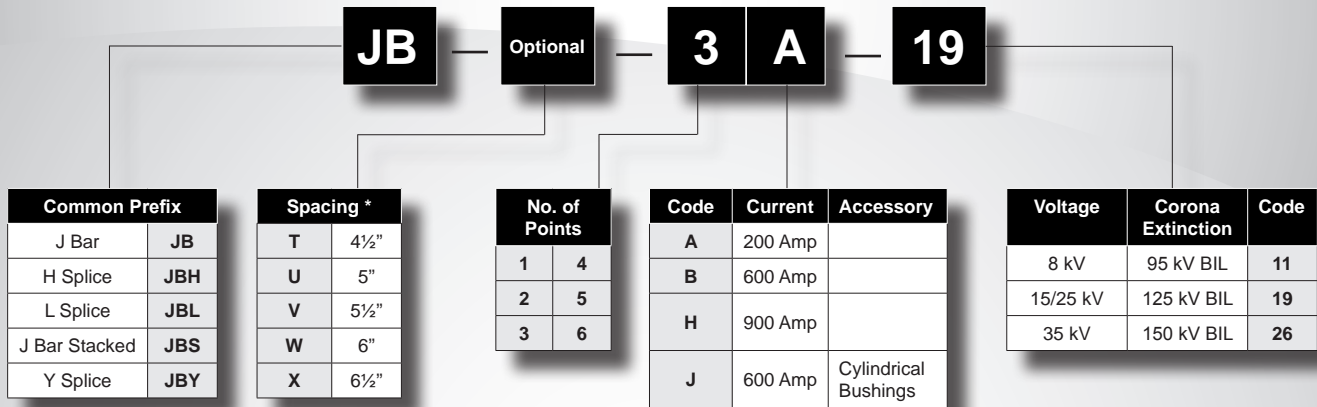

* 25kV Equipment will be configured with standard 4" spacing unless an optional value is specified here.

Combination 200/600/900 Amp

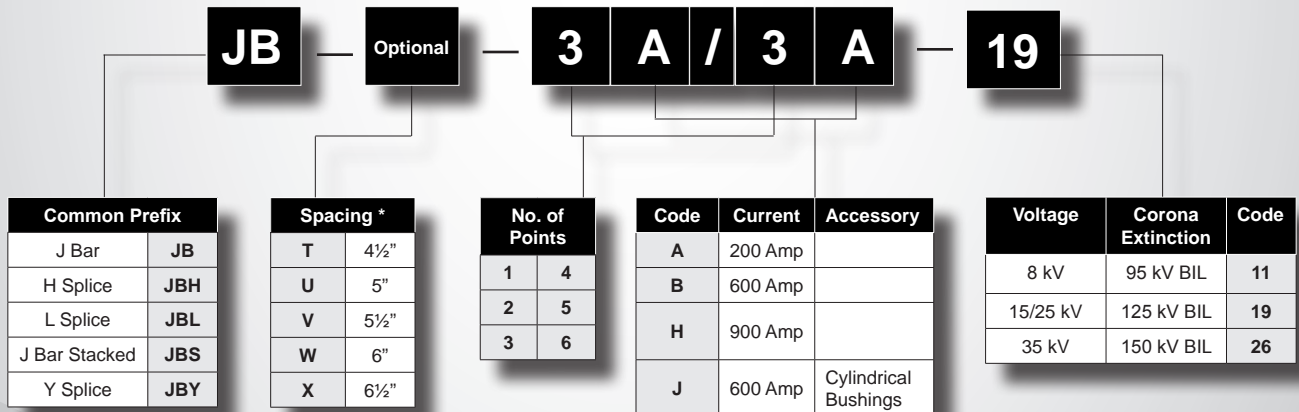

* 25kV Equipment will be configured with standard 4" spacing unless an optional value is specified here.



UTILITY PRODUCTS

CABLE TRANSITION MODULES 15/25 KV

Patton & Cooke cable transition modules (CTMs) incorporate all of the features of the electroplastic product line, but are designed for splicing paper insulated lead cable (PILC) into solid dielectric cable. CTM modules allow easy and reliable construction of single phase taps or splices from PILC distribution cable feeders. The Patton & Cooke cable transition module is the only product available that permits the direct connection of separable insulated connectors in a splice of this type.

Patton & Cooke CTMs are available in the following orientations:

- Tap
- Straight through
- Run and tap

Vault Space Requirements			
Module Type	Illustration	Space Requirements (in inches)	
		Length	Height
Straight Through		36"	12"
Tap		48"	24"
Run & Tap		64"	24"

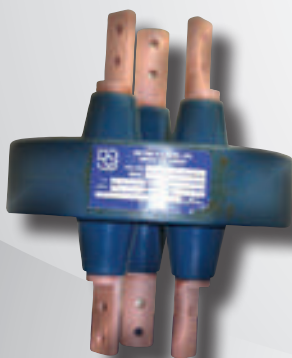
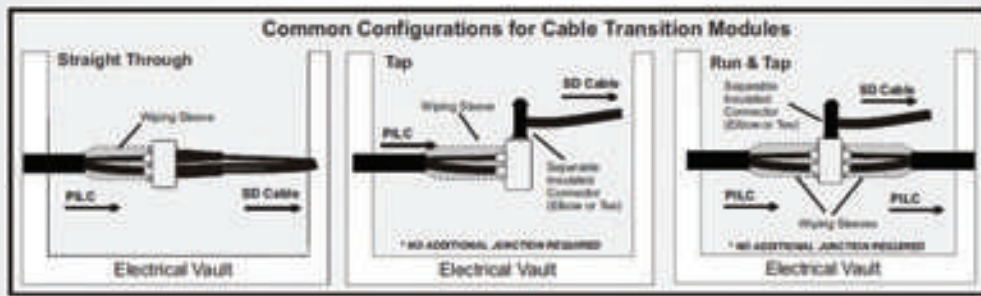

OIL STOP MODULES

Patton & Cooke oil stop modules were specifically designed for use with oil filled, lead covered cables. The oil stop module is an extension of the cable transition module product line, and is primarily used in situations where dramatic changes in elevation are present over long cable runs. The oil stop module helps prevent oil migration, which may result in premature cable damage.

CABLE TRANSITION & OIL STOP MODULE INSTALLATION ACCESSORIES

- Wiping sleeves in 12", 18", 25" overall lengths
- Wiping flanges
- Solder lugs (included)
- Mounting saddles
- Mounting brackets



CAPNUT TERMINATION (POTHEADS) 7.5/15/25/35 KV

Patton & Cooke offers capnut terminations (potheads) for single and three conductor cable systems. Potheads are designed for use where insulated cables are connected to generators, switchgear transformers, overhead lines or sectionalizing equipment. These terminations are suitable for use with common cable types including: extruded dielectric cable paper insulated lead cable and teck cable.

- Voltage ratings of 5, 8.7, 15, 25 and 35 kV
- Single and three conductor
- Accept #4 to 2000 MCM conductor sizes
- Indoor 3 phase units can be in parallel or divergent bushing orientation
- Wide selection of aerial lugs and entrance fittings



CAPNUT TERMINATIONS CATALOGUE NUMBERS

Special Feature	Code
Large body	G
Undersize body	U

Special Feature	Code
Plate mounted	P
Parallel bushing	L
Parallel bushing & plate mounted	Q
Cast flange	X

Max Cond Size	Code	Max Cond Size	Code
#4	1	600 MCM	10
1/0	2	750 MCM	5
2/0	11	1000 MCM	6
250 MCM	3	1250 MCM	7
350 MCM	3.5	1500 MCM	8
500 MCM	4	2000 MCM	9

Aerial Lugs	Code
Universal Clamp	1
Bus Type-2 Nema	2N
Bus Type-2 Nema Angled	2ND
Bus Type-4 Nema	4N
Bus Type-Horz Surface	5

Indoor	Code
Indoor	N
Outdoor	T

Body Shape	Code
Round	R
Flat	F
45 Degree	D
Back	B
Side	S

Voltage	Code
5000 V	3
8700 V	4
15000 V	5
25000 V	6

No. of Conductors
1
2
3
4

Entrance Fitting	Code
Wiping Sleeve	WS
Inv Wiping Sleeve	WSV
Wip SI & Arm Cl	WSAC
Stuffing Box	SB
Dbl Plate Stuff Box	DPL
Stuff Box & Arm Cl	SBAC
Steel Wire Arm Cl	SWAC
Conduit Coupling	CC
Stuff Box & Cond	SBCC
Teck Fitting	SBT

T F 5 3 WS 3

THRU-WALL BUSHING (SINGLE & THREE-PHASE)

The thru-wall bushing is your pothead replacement solution. It's vacuum cast from silica based thermal setting resin and replaces original porcelain bushings. Single and three phase units are available up to 35 kV and current ratings to 900 Amp.

- Resistant to extreme temperatures and harsh chemicals
- Hypalon gaskets throughout, ensuring a leakproof seal
- Can be maintained on-site and retrofitted onto existing Type RA oil switchgear
- Accept both straight receptacle housings and deadbreak separable connector elbows
- Optional closing tool is available for connecting straight receptacle housings

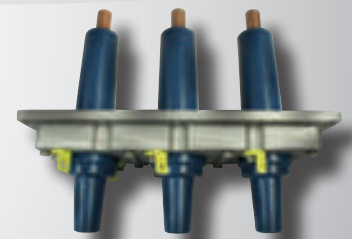



ENCLOSURES 8/15/25 KV

Patton & Cooke's enclosures are custom built to suit your needs. Whether for fixed and portable application, Patton & Cooke enclosures are built to meet our high standards and your specifications. The enclosures can be supplied for indoor or outdoor locations and for underground use in mining applications. Enclosure designs are available up to 35 kV with a range of options.

All enclosures are fitted with:

- External grounding points
- Convenient lifting points for ease of handling

Material Options	Style	Interior Options	Exterior Options	Finish
<ul style="list-style-type: none"> • Nema 4/mild steel • Nema 4x/stainless steel 	<ul style="list-style-type: none"> • Free standing • Pad mount • Skid mount • Wall mount 	<ul style="list-style-type: none"> • Stand off insulators • Copper bus • Cam clamps or compression lugs • Copper grounding points • Separable insulated connection junctions 	<ul style="list-style-type: none"> • Viewing window • Power on indicators • Entrance fittings/glands • Single or three phase cable couplers 	<ul style="list-style-type: none"> • Powder coated finish in a wide range of colour options • High voltage warning labels

DUCT CLAMPS

Patton & Cooke duct clamps provide an easy to install means for strain relief of cables passing through ducts. Duct clamps are molded from urethane and securely fastened with hose clamps for excellent cable grip. Available for single (multiconductor) cables or 3" x 1" (single phase) cables.



Cable Diameter		Patton & Cooke Catalogue No.						
(mm)	(in)	Duct Size						
		51mm 2"	64mm 2.5"	76mm 3"	89mm 3.5"	102mm 4"	127mm 5"	152mm 6"
15.9-22.2	0.625-0.875	DU-037A	DU-038A	DU-039A	DU-041A	DU-042A	DU-043A	DU-044A
22.3-28.5	0.876-1.125	DU-037B	DU-038B	DU-039B	DU-041B	DU-042B	DU-043B	DU-044B
28.6-34.9	1.126-1.375	DU-037C	DU-038C	DU-039C	DU-041C	DU-042C	DU-043C	DU-044C
35.0-41.2	1.376-1.625	-----	DU-038D	DU-039D	DU-041D	DU-042D	DU-043D	DU-044D
41.3-47.6	1.626-1.875	-----	DU-038E	DU-039E	DU-041E	DU-042E	DU-043E	DU-044E
47.7-53.9	1.876-2.125	-----	-----	DU-039F	DU-041F	DU-042F	DU-043F	DU-044F
54.0-60.3	2.126-2.375	-----	-----	DU-039G	DU-041G	DU-042G	DU-043G	DU-044G
60.4-66.6	2.376-2.625	-----	-----	-----	DU-041H	DU-042H	DU-043H	DU-044H
66.7-73.0	2.626-2.875	-----	-----	-----	DU-041J	-----	DU-043J	DU-044J
73.1-79.3	2.876-3.125	-----	-----	-----	-----	-----	DU-043K	DU-044K
79.4-85.7	3.126-3.375	-----	-----	-----	-----	-----	DU-043L	DU-044L



PATTON & COOKE CO.



WILDLIFE PROTECTORS

Patton & Cooke wildlife protectors deter the contact of birds, squirrels, etc. with transformer bushings. Wildlife protectors cover the top of transformer bushings, thereby protecting wildlife from harm and preventing possible power outages.

Patton & Cooke Catalogue No.	Description	Dimensions				Weight	
		Height		Diameter		(kg)	(lb)
		(mm)	(in)	(mm)	(in)		
PAT-11D-LSH	Molded acetate "plate" style protector is inserted between transformer bushing skirts.	62	2.44	298	11.75	0.11	0.23
PAT-11D-FA	Molded acetate "cover" style protector consists of two halves joined by a hinge for easy placement over the top of the transformer bushing.	152	6.00	178	7.00	0.18	0.39

STAND OFF INSULATORS

Patton & Cooke stand off insulators are cast from thermal setting resin and suitable for indoor applications. Stand off insulators are designed for spacing bus or connectors.



Voltage Class (kV)	Impulse Voltage (kV BIL)	Patton & Cooke Catalogue No.	Dimensions				Weight	
			Height		Diameter		(kg)	(lb)
			(mm)	(in)	(mm)	(in)		
2.5	45	IN-2.5EN-x y	64	2.50	51	2.00	0.23	0.50
5	60	IN-5NE-x y	89	3.50	102	4.00	1.14	2.50
7.5	75	IN-7NE-x y	114	4.50	102	4.00	1.36	3.00
	95	IN-15LNE-x y	152	6.00	102	4.00	1.82	4.00
15	110	IN-15HNE-x y	191	7.50	102	4.00	2.04	4.50
	25	IN-25NE-x y	267	10.50	102	4.00	2.72	6.00

No. of Holes	Bolt Size	Bolt Circle		Catalogue No. Suffix x or y	No. of Holes	Bolt Size	Bolt Circle		Catalogue No. Suffix x or y
		(mm)	(in)				(mm)	(in)	
1	1/2"-13 NC			A	2	3/8"-16 NC	51	2	B
	3/4"-10 NC			F		1/2"-13 NC	76	3	L
	5/8"-16 NC			D		3/8"-16 NC	76	3	V
	5/8"-11 NC			M	4	3/8"-16 NC	51	2	C
2	3/8"-16 NC	29	1 1/8"	T		1/2"-13 NC	76	3	E



AIRCRAFT WARNING MARKERS

Patton & Cooke aircraft markers have many years of field proven service making transmission and distribution lines clearly visible. Aircraft warning markers are manufactured of light weight, ultra-violet and weather resistant fiberglass or ABS and are designed for use in live/energized and static conditions. They can be used in suspension and thru-wire applications.



Voltage Class (kV)	Diameter		Colour	Patton & Cooke Catalogue No.	Weight	
	(mm)	(in)			(kg)	(lb)
138	762	30	White	10C10-30-WH	10	23
			Orange	10C10-30-OR		
	1321	52	White	10C3-52-WH	32	70
			Orange	10C3-52-OR		
230	762	30	White	10C3-30-WH/S	12	27
			Orange	10C3-30-OR/S		
	1321	52	White	10C3-52-WH/S	34	74
			Orange	10C3-52-OR/S		
500	762	30	White	10C3-30-WH/S5	14	30
			Orange	10C3-30-OR/S5		
	1321	52	White	10C3-52-WH/S5	35	78
			Orange	10C3-52-OR/S5		
Static Line 230	915	36	White Orange Yellow	10C3-36-WH/S 10C3-36-OR/S 10C3-36-Y/S	14	30



DUCT LINERS

Patton & Cooke duct liners provide a barrier between cable and duct entrances in vault installations. Duct liners protect cable from abrasion damage caused by contact with duct's rough surface. For maximum cable strain relief, Patton & Cooke duct clamps should be used with Patton & Cooke duct liners.

Duct Size		Patton & Cooke Catalogue No.	Dimensions					
(mm)	(in)		Length		Diameter 1		Diameter 2	
			(mm)	(in)	(mm)	(in)	(mm)	(in)
102	4	5M52-32	165	6.50	159	6.25	117	4.63
127	5	5M52-40	300	11.81	240	9.45	150	5.91



MID SPAN BRACKETS

Patton & Cooke mid span brackets are used to support secondary power lines to residences from overhead power lines.

Patton & Cooke Catalogue No.	Description	Dimensions				Weight	
		Width		Height		(kg)	(lb)
		(mm)	(in)	(mm)	(in)		
SSB-375A	For use with three (3) conductor lines. Molded black polycarbonate base with stainless steel bails	419	16.5	390	15.4	0.5	1.1
SSB-465	For use with four (4) conductor lines. Clear acrylic base with stainless steel bails.	533	21.0	457	18.0	0.5	1.7

INSULATED END CAPS

Insulated end caps are used for capping live conductors. Cast from Patton & Cooke's exclusive thermal setting resin, insulated end caps are custom fitted with superior insulating properties.



Voltage Class (kV)	Cable Type	Conductor Size	Patton & Cooke Catalogue No.	Dimensions					
				Length		Width 1		Width 2	
				(mm)	(in)	(mm)	(in)	(mm)	(in)
13	Compact Sector	#3/0 AWG	CAP-015	102	4	25	0.97	29	1.16
		300 MCM	CAP-014	110	4.31	32	1.25	36	1.41
		400 MCM	CAP-006	110	4.31	44	1.72	49	1.94
		500 MCM	CAP-013	110	4.31	35	1.38	39	1.54
		600 MCM	CAP-005	110	4.31	47	1.84	53	2.10
15	Compact Sector	#2/0 AWG	CAP-TH3	110	4.31	35	1.25	40	1.41
		350 MCM	CAP-012	110	4.31	38	1.50	42	1.66
		500 MCM	CAP-TH4	110	4.31	49	1.84	53	2.10
	Round	#2/0 AWG	CAP-TH1	110	4.31	30	1.17	35	1.34
		350 MCM	CAP-010	110	4.31	32	1.25	36	1.41
		500 MCM	CAP-011	110	4.31	35	1.38	39	1.54
			CAP-TH2	110	4.31	49	1.57	44	1.73
25	Compact Sector	350 MCM	CAP-005	110	4.31	47	1.84	53	2.10
		500 MCM	CAP-007	110	4.31	52	2.06	58	2.28

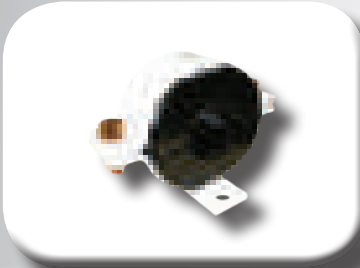

CABLE RISER BRACKETS

Patton & Cooke cable riser brackets attach insulated cable, conduit, or piping to walls, roofs, and poles. The brackets keep the cable supported and out of harms way.







No. Cables to be Supported	Max. Cable Outside Diameter		Epoxy Insert Frame			Mounting Bracket Style	*Patton & Cooke Catalogue No.
	(mm)	(in)	Qty per Assembly	Size Diameter			
				(mm)	(in)		
One	47.5	1.870	1	76.2	3.0	Low Profile	5M11B- <u>x</u>
	70.0	2.760	1	114.3	4.5	Extended	5M11- <u>x</u>
Three	24.1	0.950	1	76.2	3.0	Low Profile	5M11B-3- <u>x</u>
						Extended	5M11-3- <u>x</u>
	30.1	1.187	1	114.3	4.5	Extended	5M10-3- <u>x</u>
						Low Profile	5M8A- <u>x</u>
							Extended

*x = Cable O.D.

PATTON & COOKE COMMERCIAL & INDUSTRIAL COUPLERS

Trailing cable couplers have been widely used to connect medium voltage equipment in mining, port and mobile applications. As power demands are continually increasing, industry and utilities and large industrial consumers are looking to cable couplers to provide safe, reliable and convenient solutions for making connections.

As industrial equipment and systems grow, maintenance and costs associated with downtime are critical factors. Cable couplers can replace hard wired connectors, enabling critical components such as cables, motors or switchgear to be changed out with greater speed and with less reliance on electrical personnel. From port cranes, to large industrial motors and from 600 Volts through 25,000 Volts and with a wide range of options - Patton & Cooke couplers are the proven choice for industrial applications.

600 Volts 145,165, 225, 250, 325 Amp Versions C06/C10 Series Applications	5,000 to 8,000 Volts 250, 400, 500 Amp Versions PK/PL/C80 Series Applications	15,000 Volts 500 Amp Version C150 Series Applications	25,000 Volts 400 Amp Version C250 Series Applications
<ul style="list-style-type: none"> Mining Micro Tunneling Shore to Ship Portable Power Generation 	<ul style="list-style-type: none"> Mining Tunneling Material Handling Shore to Ship Portable Power Generation 	<ul style="list-style-type: none"> Mining Tunneling Shore to Ship Gantry Cranes Portable Power Generation 	<ul style="list-style-type: none"> Mining Tunneling Portable Power Generation 

PATTON & COOKE CO.

CORPORATE HEAD OFFICE

#100 - 7795 128th Street
Surrey, BC V3W 4E6
CANADA

Phone: 604.591.5374

Toll Free: 1.866.591.5374 (N. America)

Fax: 604.591.3505

E-mail: info@pattonandcooke.com

Web: www.pattonandcooke.com



WORLDWIDE SALES OFFICES

Patton & Cooke Co. cooperates with a growing number of highly qualified sales partners around the world who will help you find the solution just right for you.

At www.pattonandcooke.com, you can easily find an authorized Patton & Cooke agent in your area.