

SCHLAUCHSCHELLE BMF GR. 4

Ordering code: BAM00N6

Mechanical Accessories

Mounting clamp

BALLUFF

sensors worldwide

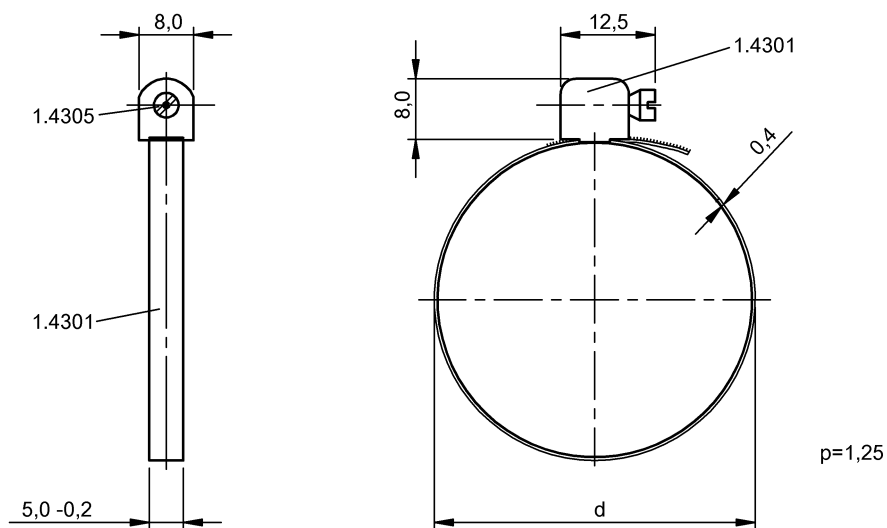

Mechanical data

Material	Stainless steel
Tightening torque for clamping	1,2 Nm
Mounting type	screwing/clamping

Basic data

Application	Ø38-49
Scope of delivery	LU210

Remarks

Definitions see main catalog

subject to change