











Back

### Type CVG (conduit and cable fitting; plastic thread)

Combined conduit and cable fitting, straight, with plastic thread.

- insert conduit → screw upper part tight → ready
- Reliable assembly because fitting is supplied pre-assembled. No additional parts required
- Resistant to vibration due to lockable cap nut
- Clamping around entire circumference, ensuring maximum tear-out strength
- High tightness corresponding to IP 68 to 6bar (IP 69K) without additional parts
- Simple check that the conduit is assembled correctly



-  RoHS compliant
-  -40 – 110 °C transient 140 °C
-  V0
-  IP 68 to 6bar (IP 69K) with additional O-ring, type OR-NBR
-  Mod. polyamide PA 6
-  UR authorisation
-  CSA authorisation
-  DB authorisation
-  BS-certification
-  SNCF authorisation

Type	Order no.	Colour	Connecting thread	Suited for Murrflex	EH mm	GL mm	LW mm	SW 1 / 2 / 3 mm	Pack qty.
Metric plastic thread									
CVG M12-K	83531050	black	M12x1.5	M12 / P9	39.0	8.0	3.0 – 6.5	20 / 15 / 20	50
CVG M16-K	83531052	black	M16x1.5	M16 / P11	45.0	8.0	4.0 – 8.0	25 / 22 / 25	50
CVG M20-K	83531056	black	M20x1.5	M20 / P16	55.0	9.0	6.0 – 12.0	33 / 24 / 33	50
CVG M25-K	83531058	black	M25x1.5	M25 / P21	57.0	11.0	13.0 – 18.0	40 / 33 / 42	50
CVG M32-K	83531060	black	M32x1.5	M32 / P29	69.0	11.0	18.0 – 25.0	50 / 42 / 50	25
CVG M40-K **	83531062	black	M40x1.5	M40 / P36	84.0	13.0	22.0 – 32.0	60 / 53 / 60	25
CVG M63-K	83531064	black	M63x1.5	M50 / P48	94.0	14.0	37.0 – 44.0	73 / 68 / 75	10

\*\* CSA authorisation

### Dimensional drawing

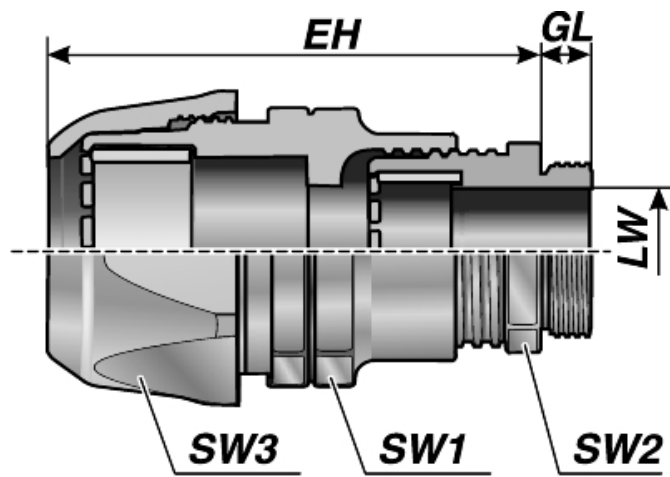

© 2001-2007 Murrplastik