

Rubber Buffers / Cellular Buffers

Program 0170 / 0180



CONDUCTIX
wampfler
Ⓞ DELACHAUX GROUP

Performance tables of our Buffers (KAT0170 and KAT0180 Load Diagrams) can be downloaded from: www.conductix.de/en

Part numbers marked with * are part of our standard range and are available from stock. Delivery times for other part numbers can be provided by request.

Contents

Rubber Buffers / Cellular Buffers – General Information	4
Rubber Buffers and Cellular Buffers at a glance	4
Project Planning.....	6
Possible Buffer Arrangements.....	6
Buffer Loads.....	6
Basic Formulas for Calculating.....	7
<hr/>	
Rubber Buffers	9
General	9
How to Order	9
Application Examples	9
Conductix-Wampfler Standard Rubber Quality	10
Quality Grades of Common Materials.....	10
Dimension Tables.....	11
<hr/>	
Rubber-Metal Elements	17
General	17
Application Examples	17
How to Order	17
Conductix-Wampfler Standard Rubber Quality	18
Quality Grades of Common Materials.....	18
Dimension Tables.....	19
<hr/>	
Cellular Buffers	25
General	25
Application Examples	25
Conductix-Wampfler Standard Cellular Buffer Quality	25
Fall Protection.....	25
Quality Grades	25
Dimension Tables.....	26
<hr/>	
Rubber Buffers / Cellular Buffers FAQs	28

Rubber Buffers / Cellular Buffers Program 0170 / 0180

General Information

Stop buffers are essentially damping units that absorb energy, for example at the end of a crane runway, to prevent damage and allow for smaller structural dimensions. In general, "energy before geometry" applies to buffers because load diagrams, precisely defined characteristic curves, physical dimensions, and mathematical formulae are used when dimensioning the buffers. Geometrical dimensions are of secondary importance here. Stop bumpers are not to be used as vibration dampers or supports.

Safety, quality, and know-how are our main focus!



Modern production methods, constantly increasing working speeds, and increasing demands for ergonomic working environment, make greater demands on existing buffer systems. Due to the wide variety of available buffer designs, we can offer a solution for every application. We have a large standard range of rubber buffers and cellular buffers to provide for individual solutions. Special designs are always possible by request.

Applications:

- Travel limitation
- Energy absorption
- End stops
- End position dampening

Rubber Buffers: Program 0170

Since rubber buffers are made from cost-effective, basic materials, our program offers an economic solution for most technical requirements. The energy absorption of a rubber buffer is limited due to the compression limits of the material.

Rubber-Metal Elements: Program 0170

Rubber-metal elements are used to support dynamic loads and isolate them from vibration. As a rule, the rubber-metal elements in this catalog are calculated based on construction attributes, as opposed to energy absorption or vibrational characteristics, given their usual application as a support member and isolation element.

Cellular Buffers: Program 0180

Due to their excellent energy absorption properties the cellular buffer program is a suitable complement to the rubber buffer program. Their volume compressibility allows long compression lengths and very good deceleration values.

Rubber Buffers and Cellular Buffers at a glance



- Highest dynamic and mechanical capacity
- Versatile resilience against demanding environmental conditions
- Compression travel up to 50% buffer height

- High energy absorption abilities make cellular buffers a maintenance-free and inexpensive alternative to complex buffer systems.
- Low delay values and very good damping qualities
- Lightweight design
- Compression travel up to 80% buffer height

Rubber Buffers / Cellular Buffers Program 0170 / 0180

Fall Protection

Accidental falling of the stop bumpers is prevented by safeguard measures – so-called “fall protection” – which provides comprehensive safety for man and machine. Cellular bumpers with integrated safety rope and form-fitting, foam-covered cap are used for installation heights > 3 m. Fall protection is a standard feature for all cellular bumpers. The reliable vulcanization process, permanently joining the fastening element to the rubber bumper body, adds to the overall safety of the bumpers. We take special care when choosing the raw material for our bumpers, using only the best quality materials. This results in homogenous base compounds, very high durability, and consistently excellent energy absorption of the bumpers. Years of experience and continued development by the inventor of stop bumpers, Manfred Wampfler, still form the knowledge base of bumper manufacturing to this day.

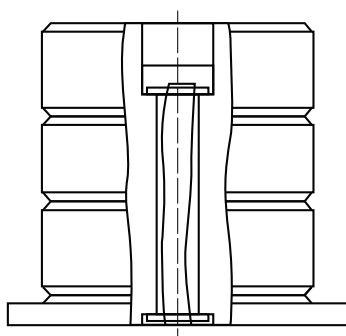
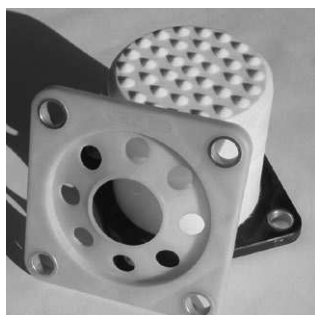

Integrated safety rope
(250 mm buffer diameter or higher)

Placement

Mounting surfaces and counter-pressure surfaces must be level and parallel with the bumper. This avoids lateral forces and ensures a concentric, linear application of force and an impact over the whole reception area of the bumpers.

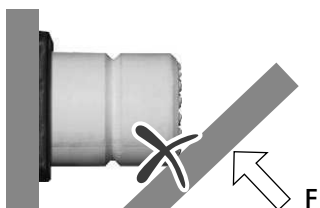
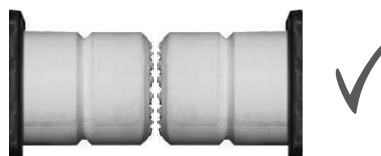
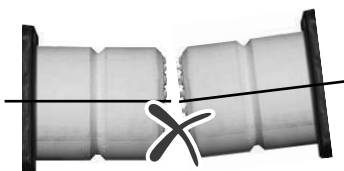

Vertical eccentricity of oppositely mounted buffers must not be higher than 10% of the buffer's diameter:

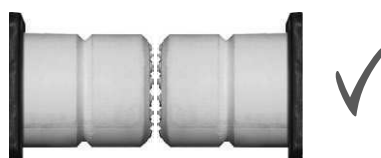
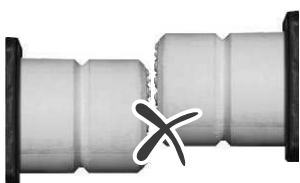

Rubber Buffers / Cellular Buffers Program 0170 / 0180

Project Planning

- Determine the effective mass and impact velocity
- Calculate the basic energy formula: $W = \frac{1}{2} m \times v^2$
- Determine the energy distribution for each single buffer
- Select the needed buffer (cellular or rubber material), depending on general requirements
- Select the buffer geometry according to max. buffer energy W_{max} from the tables on pages 11, 26, and 27 depending on the bumper type.
- Calculate the expected compression length
(from diagram – see catalogs “Load Diagrams - Rubber Bumpers” and “Load Diagrams - Cellular Bumpers” on www.conductix.com)
- Calculate the resulting reacting force
- Check the resulting deceleration

Possible Buffer Arrangements

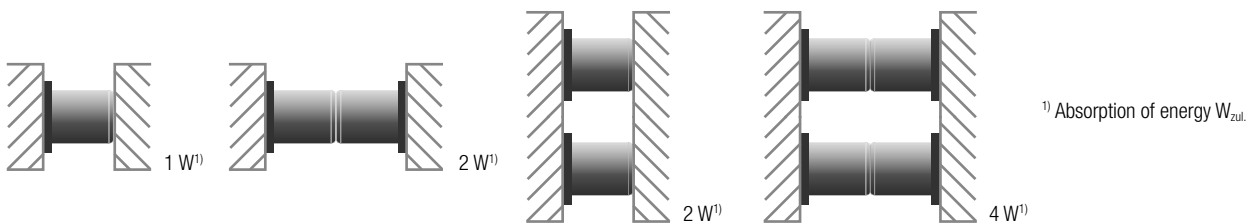

Buffer Loads

The load on the bumpers has to be centered and perpendicular to the bumper base plate. Do not weld the bumper base plate to the host surface. Use mounting screws according to DIN 6912 or DIN 7984.

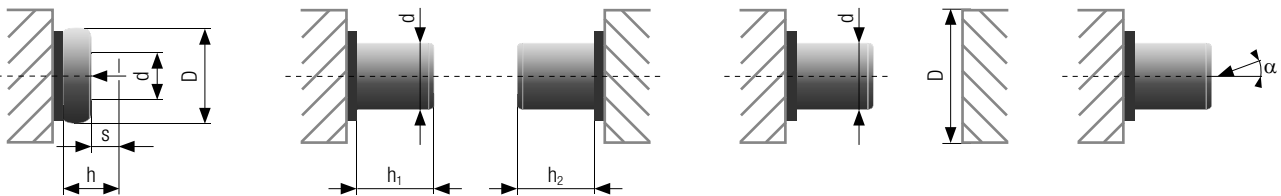

Diameter expansion with maximum load:

- Rubber buffer:
 $s = 0.5 h \hat{=} D = 1.4 d$
- Cellular buffer:
 $s = 0.5 h \hat{=} D = 1.25 d$
 $s = 0.8 h \hat{=} D = 1.4 d$

Bumper against bumper arrangement (cellular bumpers):

- Permissible:
 $h_1 + h_2 \leq 2 d$
- Not permissible:
 $h_1 + h_2 > 2 d$

Because of variations in guiding and impact accuracy, the impact surface must be at least 25% greater than the buffer diameter: $D > 1.25 d$
 $D =$ impact surface
 $d =$ buffer diameter

Impact direction:

$$\alpha_{max} = \pm 4^\circ$$

Bumper characteristics are shown by the load-length curves. With rubber bumpers the shape of the curves mainly depends on the shape and the shore hardness.

With cellular bumpers, volumetric density is the decisive factor for their physical behavior. Due to the spring characteristic curve of rubber and cellular bumpers (load F depending on the compression length s) the bumper final pressures, which are required for the specification of the neighboring components, can only be determined with static tests.

- $A1 =$ energy loss (hysteresis)
- $A2 =$ restoring energy
- $A1 + A2 =$ energy absorbed by the bumper

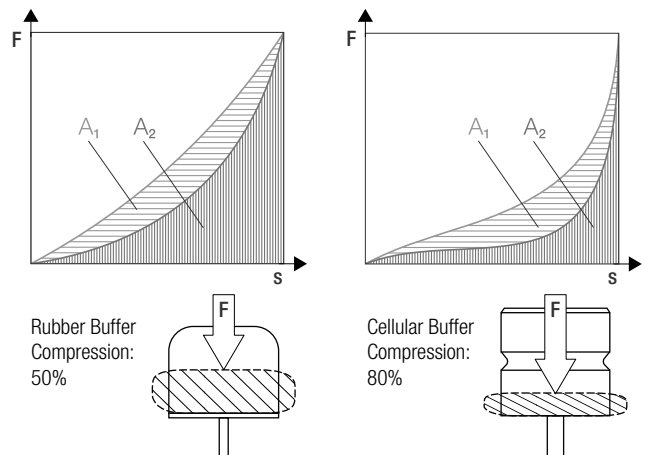

Rubber Buffers / Cellular Buffers Program 0170 / 0180

Basic Calculation Formulas

- Mass against limit stop

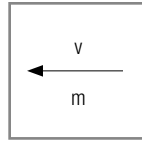
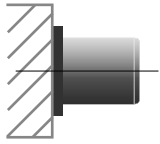

$$W = \frac{1}{2}m \cdot v^2$$

- Mass against mass

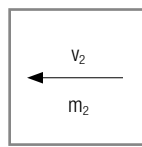
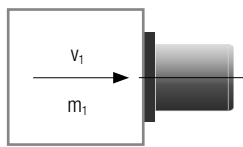

$$W = \frac{m_1 \cdot m_2 (v_1 + v_2)^2}{2(m_1 + m_2)}$$

$$m_1 = m_2 \text{ und } v_1 = v_2$$

$$W = m \cdot v^2$$

- Driven mass against limit stop

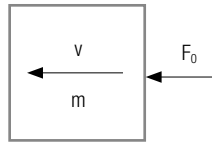
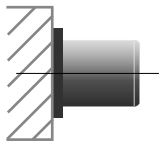

$$W = \frac{1}{2}m \cdot v^2$$

$$W_2 = F_0 \cdot f'$$

Buffer force-travel diagram

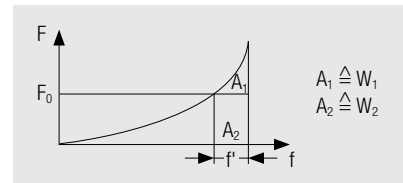

- Free fall (this formula does not apply for elevators)

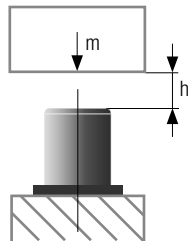

$$W = m \cdot g \cdot h$$

- Calculation of buffers for cranes

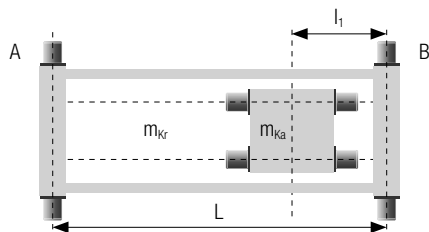

$$W_B = \frac{1}{2}m_B \cdot v^2$$

$$m_B = \frac{m_{kr}}{2} + \frac{m_{ka}(L-l_1)}{L}$$

- Oscillating masses not taken into account
- Centrifugal moment of rotating parts must be taken into account
- Velocity must be reduced according to DIN 15018:
 $v = 100\%$ rated velocity on trolleys
 $v = 85\%$ rated velocity on cranes
 $v = 70\%$ rated velocity on cranes with brakes

- Formulas for calculating the deceleration

$a_{mitt} = \frac{v^2}{2f}$	a_{mitt} : Median deceleration (m/s ²)	h : Drop height (m)	m_B : Mass on rail B (kg)
	a_{max} : Maximum deceleration (m/s ²)	L : Rail spacing (m)	v : Velocity (m/s)
$a_{max} = \frac{F}{m}$	F_0 : Driving force (kN)	l : Distance m_{ka} to B (m)	v_{12} : Velocity body 1 / body 2 (m/s)
	F : Maximum buffer force (kN)	m : Mass (kg)	w : Kinetic energy (kJ)
	f : Compression length (mm)	m_{kr} : Mass crane without trolley (kg)	w_1 : Kinetic energy (kJ)
	f' : Acting compression (mm)	m_{ka} : Mass of trolley (kg)	w_2 : Work acting through F_0 (kJ)
	g : Gravity acceleration (9.81 m/s ²)	m_1/m_2 : Mass body 1 / body 2 (kg)	w_{zul} : Max. energy absorption (kJ)



Rubber Buffers Program 0170

General Information

Natural caoutchouc rubbers are characterized by their very high elasticity, notch impact resistance, and good abrasion resistance. Among all elastomers, these have the highest mechanical and dynamic load capacities. Natural caoutchouc is not resistant to electrolytic liquids, aliphatic, aromatic hydrocarbons, or chlorinated hydrocarbons.

Oil and natural gas are the basic materials for synthetic caoutchouc. For many years, this has been a substitute material for natural caoutchouc, but today synthetic caoutchouc is increasingly used as first choice for many applications. Today there are a wide range of synthetic caoutchoucs, whose properties allow a variety of applications thereby establishing the use of rubber technology within modern methods. Rubber is not merely a chemical substance, but a compound of many different materials.

The varied mechanical and anti-corrosive properties can only be achieved by a recipe of several hundred substances. Caoutchouc, as a macro-molecular material, provides the elastic components of the rubber. The mechanical properties, such as breaking elongation, resilience elasticity, strength, and continuous breaking strength are dependent on it. The addition of chemicals and other additives and the subsequent vulcanization process make the material useful.

The multitude of additive combinations as well as the many physical forms means that for most problems there is a solution.

Rubber buffers are molded to the metal base plates. In rubber buffers with threaded bolts, the bolts are inserted twist-proof. Visible areas are primed or galvanized, respectively.

Example Part Number

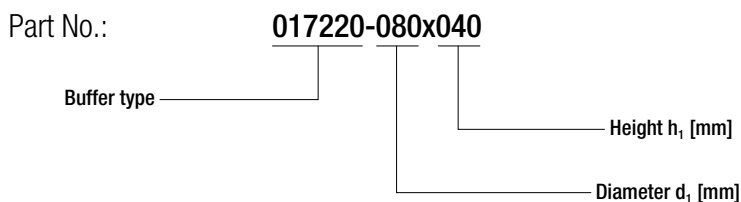

Application Examples

- Crane systems
- Transfer cars
- Smelter and rolling mill machines
- Handling technology
- Plant construction and engineering
- Conveyor, transport, and gate systems, etc.

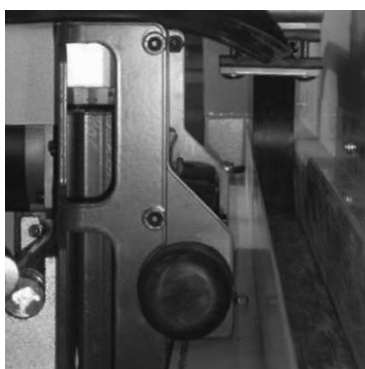
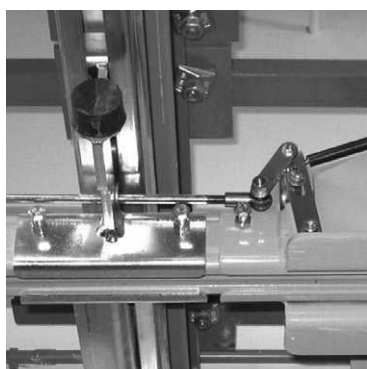

Rubber Buffers Program 0170

Conductix-Wampfler Standard Rubber Quality

N-Quality

- Resilient and tear-resistant
- Aging resistant
- Material incompressible
- Operating temperature: -30 to +70°C*
- Hardness: 70 Shore A +/-5

S-Quality (by request only)

- Seawater and ozone-resistant, weather-proof, oil and to a large extent acid and aging resistant
- Operating temperature: -30 to +80°C
- Hardness: 70 Shore A +/-5

Special qualities and special constructions by request!

* Characteristics may change depending on ambient temperature

Quality Degrees of the Most Common Materials

Conductix-Wampfler Qualities	N		Special Qualities ¹⁾			
	NR Natural caoutchouc	CR Chloroprene caoutchouc	SBR Styrene-Butadiene caoutchouc	EPDM Ethylene-Propy- lene Terpolymere	NBR Nitrile-Butadien caoutchouc	VMQ Silicone caoutchouc
Abrasion resistance	++	++	++	+	++	--
Breaking elongation	+++	++	++	+	++	○
Tear resistance	++	++	+	+	+	---
Rebound resistance	++	+	+	+	+	+
Tensile strength not reinforced	+++	+	--	--	--	---
Tensile strength reinforced	+++	++	++	+	++	○
Temperature resistance, hot air	+90 °C	+120 °C	+100 °C	+150 °C	+130 °C	+200 °C
Temperature resistance, coldness	-50 °C	-30 °C	-40 °C	-40 °C	-40 °C	-80 °C
Alkali resistance	+	++	+	++	+	--
Aging resistance	+	++	+	+++	+	+++
Gasoline resistance	---	++	○	--	+++	--
Electrical insulation resistance	+++	+	++	++	4	+++
Oil and grease resistance	---	++	--	○	+++	+++
Ozone resistance	○	++	○	+++	+	+++
Acid resistance	+	++	+	+++	○	--
Hot water	+	+	++	++	+	--

Quality degrees of the individual material properties (depending on interactions and exposure time):

+++ = very good; ++ = good; + = satisfactory; ○ = sufficient; -- = deficient; --- = insufficient

Tolerances of the rubber parts according to ISO 3302-1M

¹⁾ Special qualities available only in large order quantities – please contact us!

Rubber Buffers Program 0170

Conical Buffers with Threaded Bolt

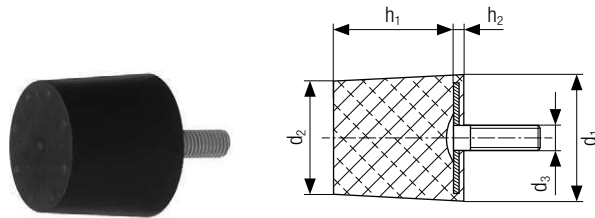

Part No.	W _{max} [J]	F [kN]	Weight [kg]	d ₁ [mm]	d ₂ [mm]	d ₃ [mm]	h ₁ [mm]	h ₂ [mm]	l [mm]	PU ¹⁾ [Qty.]
017220-016x006,3	1.2	0.9	0.008	16	15.5	M5	6.3	0.5	20	1
017220-016x008	1.5	0.9	0.009		15.0		8			125
017220-016x010*	1.8	0.9	0.010		15.0		10			1
017220-016x012,5	2.2	0.9	0.011		14.5		12.5			125
017220-016x016*	2.8	0.9	0.012		14.0		16			1
017220-020x008	2.5	1.8	0.013	20	19.5	M6	8	0.6	25	1
017220-020x010	3.0	1.65	0.016		19.0		10			100
017220-020x012,5	3.8	1.5	0.019		18.5		12.5			1
017220-020x016	4.8	1.4	0.021		18.0		16			100
017220-020x020	6.0	1.35	0.023		17.5		20			1
017220-025x010	7.0	4.6	0.025	25	24.0	M6	10	0.6	25	1
017220-025x012,5	8.0	4.0	0.027		23.5		12.5			100
017220-025x016*	10.0	3.5	0.029		23.0		16			1
017220-025x020	12.0	3.2	0.031		22.5		20			100
017220-025x025*	15.0	3.0	0.034		22.0		25			1
017220-032x012,5	22.5	12.5	0.046	32	31.5	M8	12.5	2.3	28	100
017220-032x016	23.0	8.8	0.049		30.0		16			100
017220-032x020*	24.0	7.0	0.053		29.5		20			1
017220-032x025	25.5	5.8	0.057		29.0		25			100
017220-032x032*	27.5	5.0	0.064		28.5		32			1
017220-040x016	51.0	17.5	0.069	40	38.0	M8	16	2.8	28	1
017220-040x020	53.0	13.5	0.075		37.5		20			100
017220-040x025	55.0	11.0	0.082		37.0		25			100
017220-040x032*	57.5	9.0	0.090		36.5		32			1
017220-040x040*	60.0	7.5	0.100		36.0		40			1
017220-050x020	70.0	22.5	0.121	50	47.5	M10	20	3.0	32	50
017220-050x025	75.0	18.0	0.131		47.0		25			50
017220-050x032*	80.0	15.0	0.145		46.5		32			1
017220-050x040*	90.0	13.0	0.160		46.0		40			1
017220-050x050	100.0	11.0	0.179		45.5		50			50
017220-063x020*	150.0	40.0	0.202	63	60.5	M10	20	4.0	31	1
017220-063x025	160.0	37.0	0.218		60.0		25			25
017220-063x032*	170.0	32.5	0.241		59.5		32			1
017220-063x040	180.0	28.5	0.266		59.0		40			25
017220-063x050*	200.0	25.0	0.297		57.5		50			1
017220-063x063	220.0	21.0	0.337		56.0		63			25
017220-080x020*	255.0	85.0	0.331	80	77.5	M12	20	4.2	36	1
017220-080x025	275.0	70.0	0.358		77.0		25			25
017220-080x032	290.0	58.5	0.396		76.5		32			25

* Standard range

Rubber Buffers Program 0170

Conical Buffers with Threaded Bolt (Cont'd.)

Part No.	W _{max} [J]	F [kN]	Weight [kg]	d ₁ [mm]	d ₂ [mm]	d ₃ [mm]	h ₁ [mm]	h ₂ [mm]	l [mm]	PJ ¹⁾ [Qty.]
017220-080x040*	320.0	50.0	0.437	80	76.0	M12	40	4.2	36	1
017220-080x050	350.0	42.0	0.490		74.5		50			25
017220-080x063	390.0	34.0	0.556		73.0		63			25
017220-080x080*	450.0	27.5	0.643		71.5		80			1
017220-100x020*	370.0	150.0	0.506	100	97.5	M12	20	5.2	35	1
017220-100x025	400.0	90.0	0.549		97.0		25			10
017220-100x032	425.0	75.0	0.609		96.5		32			10
017220-100x040	470.0	65.0	0.676		96.0		40			10
017220-100x050*	510.0	57.5	0.760		94.5		50			1
017220-100x063	580.0	50.0	0.867		93.0		63			10
017220-100x080	650.0	45.0	1.007		91.5		80			10
017220-100x100*	750.0	40.0	1.168		90.0		100			1

* Standard range

1) = Packing Unit = Minimum Order Qty.

Tolerances of the rubber parts according to ISO 3302-1M3

Conical Buffers with Mounting Holes

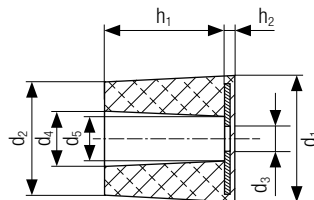

Part No.	W _{max} [J]	F [kN]	Weight [kg]	d ₁ [mm]	d ₂ [mm]	d ₃ [mm]	d ₄ [mm]	d ₅ [mm]	h ₁ [mm]	h ₂ [mm]	PJ ¹⁾ [Qty.]
017230-016x008	0.9	0.6	0.004	16	15.0	ø 5.3	10.0	9	8	2.0	1
017230-016x010	1.0	0.5	0.005		15.0		10.0		100		
017230-016x012,5	1.1	0.4	0.005		14.5		10.5		100		
017230-016x016*	1.25	0.38	0.006		14.0		11.0		1		
017230-020x010	1.6	1.1	0.008	20	19.0	ø 6.4	12.0	11	10	2.1	1
017230-020x012,5	1.7	0.8	0.008		18.5		12.5		100		
017230-020x016	1.8	0.5	0.009		18.0		13.0		100		
017230-020x020*	1.9	0.3	0.010		17.5		13.5		1		
017230-025x010	5.9	4.5	0.014	25	24.0	ø 6.4	12.0	11	10	2.1	100
017230-025x012,5	6.1	3.2	0.015		23.5		12.5		100		
017230-025x016	6.5	2.1	0.017		23.0		13.0		100		
017230-025x020	7.0	1.6	0.019		22.5		13.5		100		
017230-025x025*	7.8	1.3	0.021	22.0	14.0	1					
017230-032x012,5	13.0	6.5	0.023	32	31.5	ø 9.4	15.5	14	12.5	2.3	100
017230-032x016	13.5	4.4	0.025		30.0		16.0		100		
017230-032x020	14.0	3.1	0.028		29.5		16.5		100		
017230-032x025	14.5	2.5	0.032		29.0		17.0		100		
017230-032x032*	15.0	2.0	0.037	28.5	17.5	1					

* Standard range