

Ropes and Accessories Program 0210 and 0215

System Components for Wire Ropes with Diameter 6-12 mm

System Components
for Rope \varnothing 6 mm

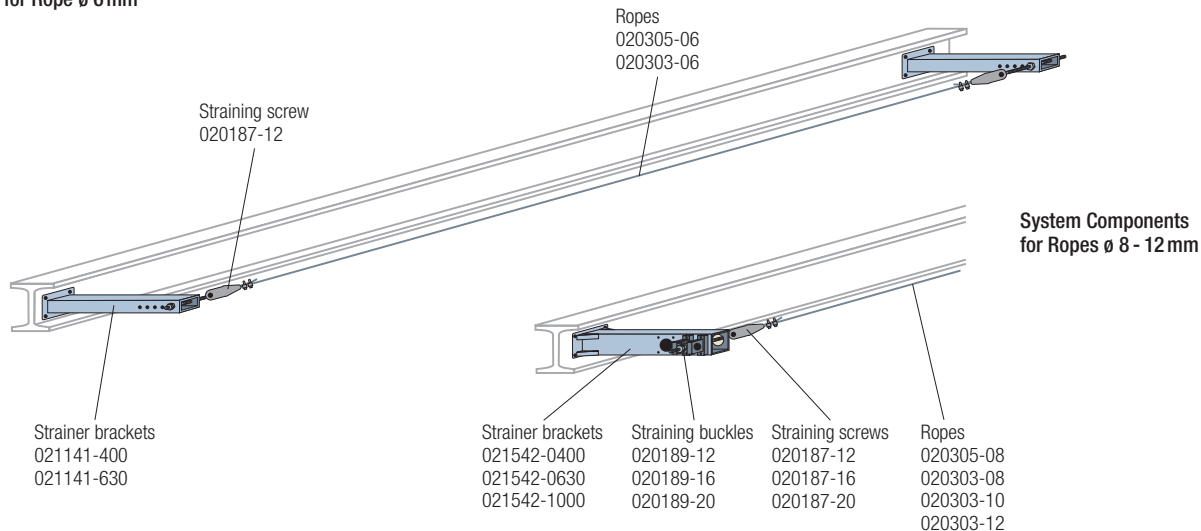

System Components
for Ropes \varnothing 8 - 12 mm

Wire Ropes

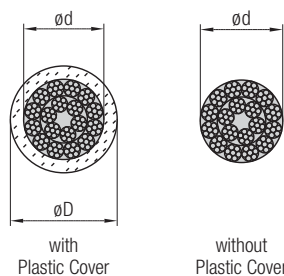

Material

- Rope: galvanized steel
- Cover: plastic

Note

Plastic covered ropes 020305 have the best performance.

Order No.	Type	$\varnothing d$ [mm]	$\varnothing D$ [mm]	Min. Brak. Strength F_{Br} [kN]	Perm. Tensil Strength F_{zul} [kN]	for Straining Screw
020305-06	with plastic cover	4	6	14.5	3.6	020187-12
020303-06	without plastic cover	6	-	20.3	5.1	020187-12
020305-08	with plastic cover	6	8	20.3	5.1	020187-12
020303-08	without plastic cover	8	-	37.2	9.3	020187-12
020303-10		10	-	58.1	14.5	020187-16
020303-12		12	-	81.2	20.3	020187-20

Straining Screws

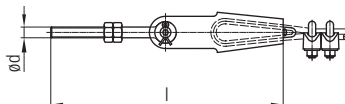

Order No.	$\varnothing d$	l [mm]	for Rope \varnothing [mm]
020187-12	M12	330	6 - 8
020187-16	M16	424	10
020187-20	M20	458	12

Material: galvanized steel

Ropes and Accessories Program 0210 and 0215

Straining Buckles

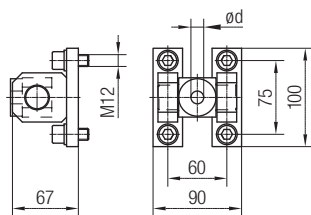

Order No.	$\varnothing d$ [mm]	suitable Strainer Bracket
020189-12	13	021542
020189-16	17	
020189-20	21	

Material: galvanized steel
Application: for flexible reception of the straining screw

Strainer Brackets

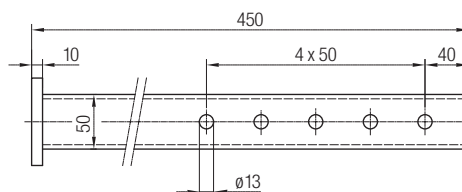
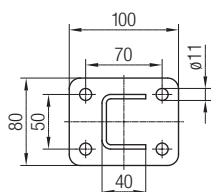

Order No.: 021141-400
Material: galvanized steel

Suitable straining screw 020187-12

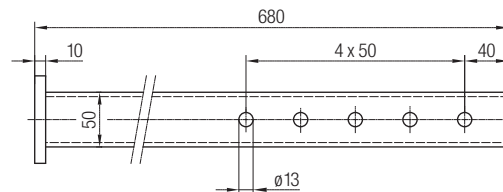
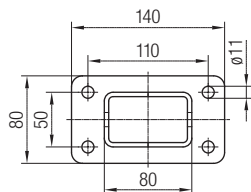

Order No.: 021141-630
Material: galvanized steel

Suitable straining screw 020187-12

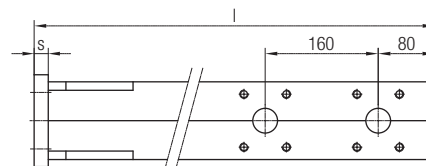
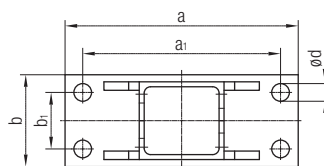

Order No.	l [mm]	a [mm]	b [mm]	a ₁ [mm]	b ₁ [mm]	$\varnothing d$ [mm]	s [mm]
021542-0400	495	290	120	250	80	21	15
021542-0630	730	330	130	280	80	25	20
021542-1000	1105	390	150	330	90	31	25

Material: galvanized steel

Notes

- To be ordered only in connection with straining buckle 020189
- This strainer bracket is also used with two ropes running in parallel
Distance between ropes = 160 mm